



For Android™ 13

Tablet PC

PT11

User Manual

Instruction

This manual provides information about basic features and using the PT11. Please read this manual carefully before using your device and peripherals to ensure safe and proper use.



Note: Screenshots in this manual may differ from actual screens.

Revision History

Revision	Date	Description
v1.0	05 Jan 2024	Initial release
v2.0	23 Feb 2024	Added Multi window, Screen cast, and Hotspot & tethering features description Added description for the 'No command' state when entering the recovery mode Added double tap for turning on/off screen description Updated the features in the Tablet Parts chapter revised the charging image to C-to-C cable
v2.1	20 Mar 2024	Changed back cover (Updated company address)

PT11 SKUs

The contents of this manual can cover the following SKUs.

SKU	Part Number	Network	RAM / Flash	Camera	OS
SKU1	PT11G8003FNK0C	LTE, WiFi/BT	8G/128G	Front & Rear Camera	Android 13 GMS
SKU2	PT11G1003FNK0C	WiFi/BT			

Table of Contents

INSTRUCTION.....	1
Revision History	1
PT11 SKUs	1
GETTING STARTED.....	4
Tablet Parts.....	4
Product Standard Accessories	5
Install SD & SIM cards	6
Charge the Tablet	8
LED Indicator	10
Turn On / Off the Tablet	11
Use a Touch Screen	12
LEARNING THE BASICS	15
Setup Wizard	15
Home Screen	16
MTP Connection with PC	24
Manage the Files.....	25
Lock the Screen	26
Multi Window.....	27
Screen Cast	28
Settings.....	29
USING THE BUTTONS.....	32
Screenshot.....	32
CAMERA	33
WIRELESS	34

Table of Contents

Mobile Network	34
Wi-Fi.....	35
Hotspot & Tethering	36
Bluetooth.....	37
SYSTEM MAINTENANCE	40
System Information	40
OS Update	41
Factory Data Reset	44
SAFETY INFORMATION	46
Battery Safety Information.....	46

Getting Started

Tablet Parts

Figure 1 PT11 views

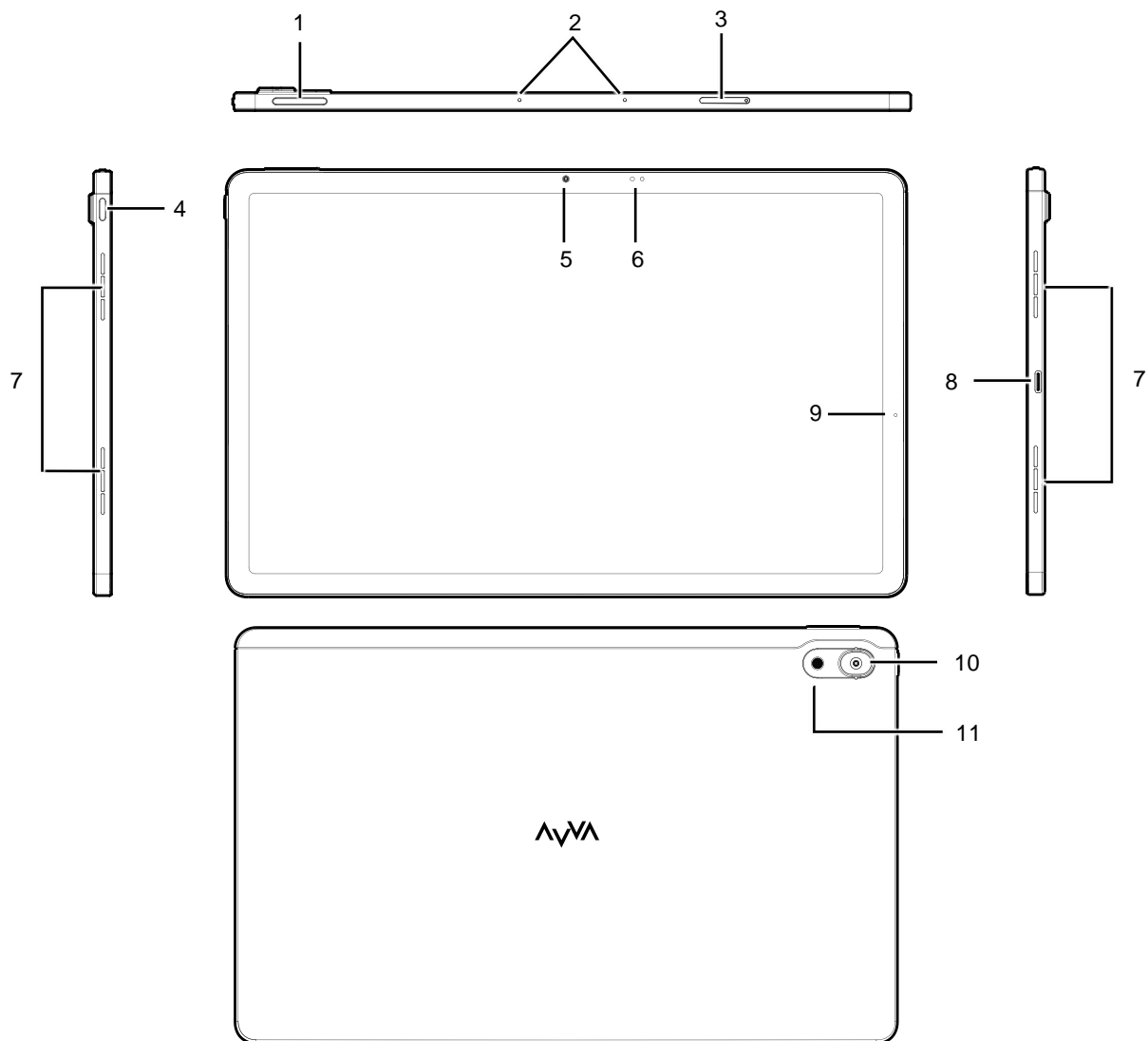

No	Name	Description
1	Volume buttons	Control the volume
2	Microphones	Use for collecting sound
3	Card tray	Insert SIM and SD cards
4	Power button	Turn on/off the tablet
5	Front camera	Take a picture
6	Sensors	Proximity and light ambient sensors

Getting Started

7	Speakers	Ring system sound
8	USB connector	USB Type C connector for charging and data communication
9	LED indicator	Indicate the power status. Refer to LED indicator .
10	Rear camera	Take a picture
11	Flashlight	Use flashlight in camera or torch mode

Product Standard Accessories

The following items are in the product box.

- PT11
- USB type C cable (C to C)
- Card tray eject pin

Getting Started

Install SD & SIM cards

PT11 supports

- microSD card
- Nano SIM card – LTE SKU only

You can find the card tray on the top of the tablet. Depending on SKU, the equipped card slots are different. Refer to the following table.

Figure 2 PT11 Card tray

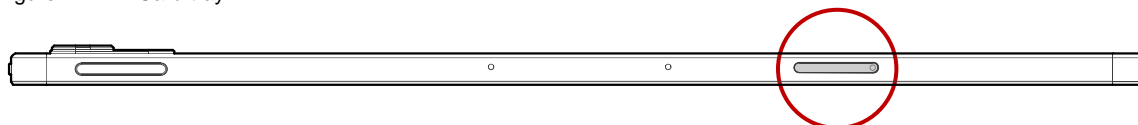

Wi-Fi SKU	LTE SKU
A diagram of the card tray for the Wi-Fi SKU. It shows a single rectangular slot on the right side, labeled 'microSD'.	A diagram of the card tray for the LTE SKU. It shows two rectangular slots on the right side. The top slot is labeled 'SIM' and the bottom slot is labeled 'microSD'.

Getting Started

1. Insert and push the card tray eject pin to the card tray hole of the PT11.

Figure 3 Eject PT11 card tray

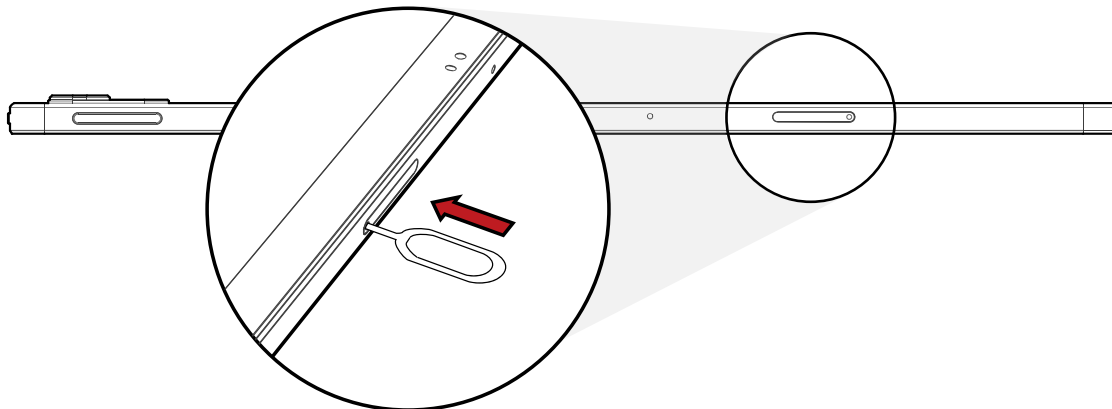

2. When card tray is opened, pull the tray out.

Figure 4 Removing card tray

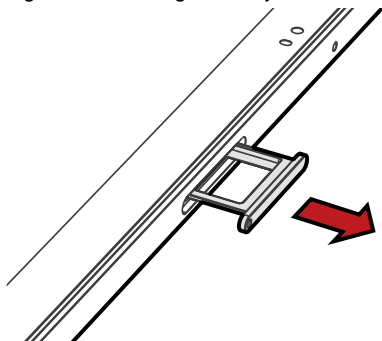

3. Put the card with the gold contacts facing down.

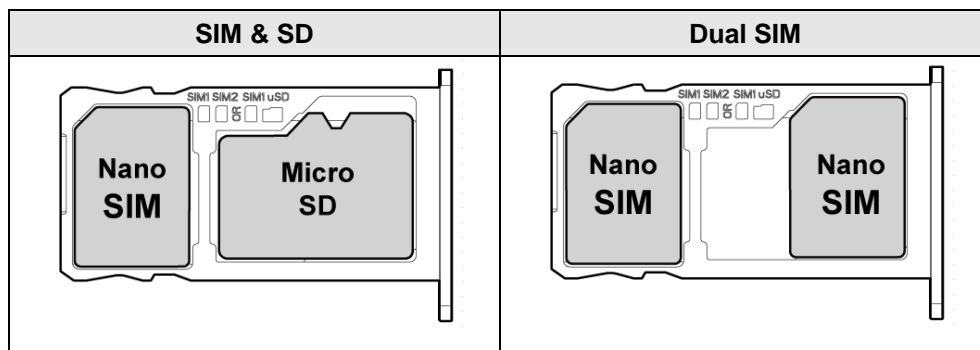

4. Insert the card tray into PT11.

Getting Started

Charge the Tablet

Before using PT11, charge the tablet enough to use. PT11 can be charged with power adapter. For best charging performance and safety, follow the normal [charging temperature](#).



Caution: Always use an original cable from Point Mobile. Other cables may damage PT11. Also, make sure the charger and cables are not wet.

Follow the [Battery Safety Information](#) for safety of using the battery.

Battery specification

- Capacity:
 - Standard battery: 8,000mAh
- Rechargeable battery

Charging temperature

Charge tablet in temperatures from 0 °C to 45 °C. At out-of-normal range temperatures, the PT11 may stop charging for safety.

Getting Started

Charge with power adapter

1. Assemble the power adapter and USB type C cable.
2. Connect the cable to the USB connector on the right side of the PT11.
3. Provide power by plugging the power adapter to the wall socket.

Figure 5 PT11 charging with power adapter

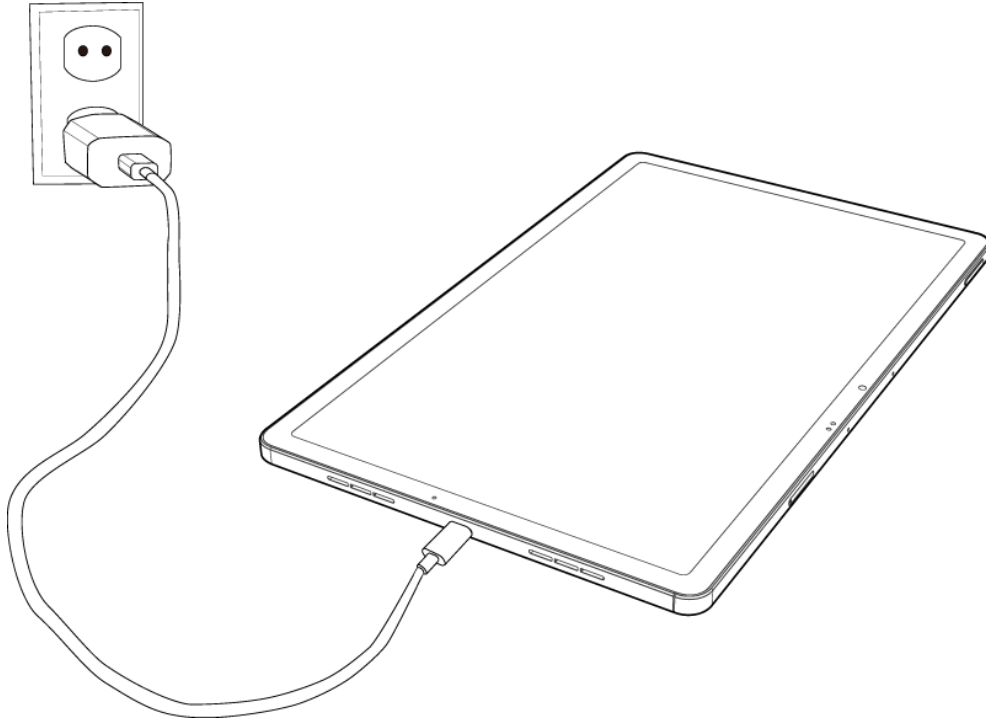



Getting Started

LED Indicator

PT11 has a LED indicator.

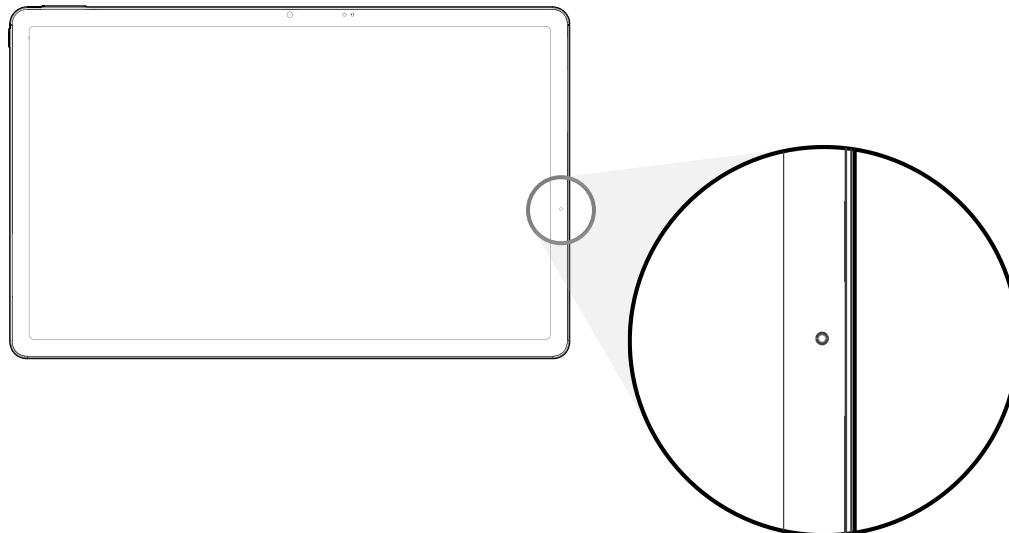
Figure 6 PT11 LED indicator



Indicator	Status	Indication
Power LED	 Solid green	Tablet is completely charged
	 Solid red	Tablet is charging

Getting Started

Turn On / Off the Tablet

To turn on the tablet,

- Press and hold the power button on the upper-left side of the tablet.

Figure 7 PT11 power button

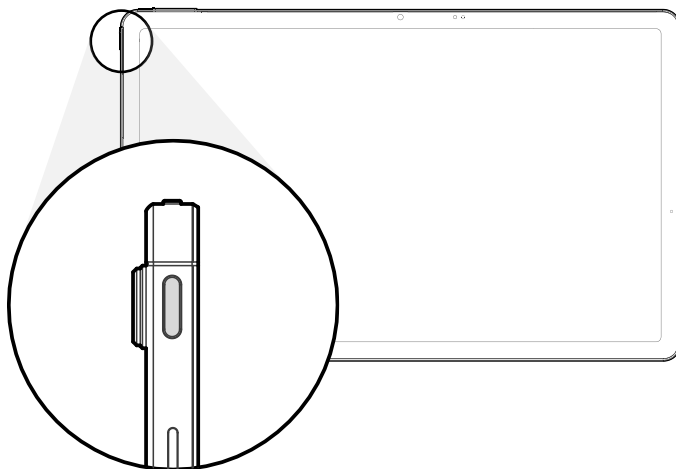

To turn off the tablet,

- Press and hold the **power button and volume up button simultaneously** to show the power menu. Then, tap **Power off**.

Figure 8 Power menu - Power off

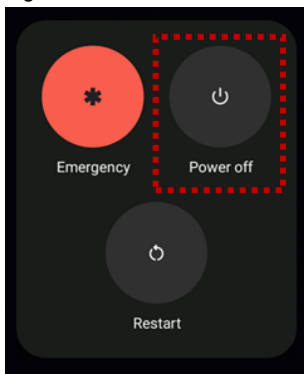

Getting Started

Use a Touch Screen





Turn on / off the screen

To turn on or off the screen, tap the touch screen twice.

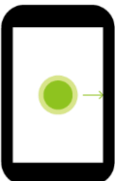
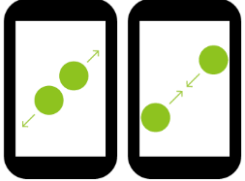

Note: To turn off the screen, tap a blank space in the host screen or lock screen twice.

Controlling the touch screen

Gesture	Description
	Tap One-finger press
	Long-press One-finger press, wait, lift for select action
	Drag, Swipe, or Fling One-finger press, move, lift for scroll or tilt action
	Long-press drag One-finger press, wait, move, lift for pick up and move, or select multiple items action
	Pinch Open & Close Two-finger press, move outwards and inwards, lift for zoom in / out action
	Rotate When PT11 is turning sideways, screen orientation is changing

Getting Started

System navigation

Navigation bar (Software button)

The navigation bar is enabled as a default, and it is located at the bottom of the screen. The app overview button, home button, and back button are placed on the bar in order.

Figure 9 Navigation bar

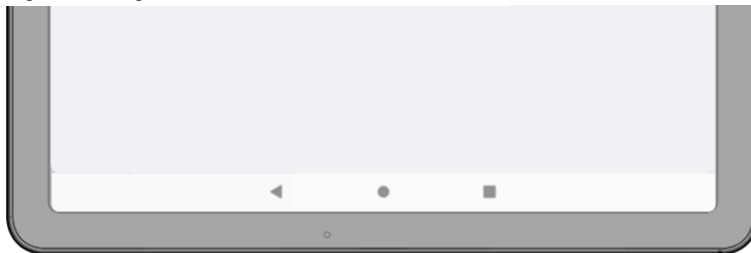

Shape	Button	Function
◀	Back button	Tap to go back to previous screen.
●	Home button	Tap to go to home screen. Long-press to launch the Google Assistant.
■	Recent apps button	Tap to see the recently used app list.

Getting Started

Gesture Navigation

If you are unfamiliar with the navigation bar or you want to see the screen with a wider screen, hide the navigation bar. The functions provided by the software buttons on the navigation bar can be used by using specific gestures.

To hide the navigation bar, navigate to **Setting**  **> System > Gesture > System navigation** and change the setting to **Gesture navigation**. Then, the navigation bar will be hidden.



Note: To use the navigation bar again, change the setting to **3-button navigation**.

Find the gestures and matched function in the table below.

Figure 10 Gesture navigation

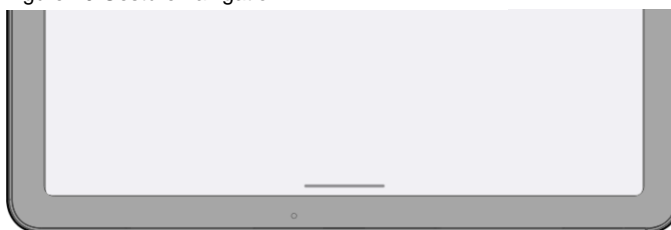

Function	Gesture
Open recent apps screen	Swipe up from the bottom of the screen, hold, then release.
Go to home screen	Swipe up from the center-bottom of the screen.
Back to previous screen	Swipe from the left or right edge of the screen.
Launch Google Assistant	Swipe up from either the left-bottom or right-bottom.

Learning the Basics

Setup Wizard

When PT11 starts very first time or boot after factory reset, Setup Wizard is launched. Following the steps on the screen, set system language, Google account, Wi-Fi connection and copy the data, etc.

Some settings can be skipped, but there may be some restrictions on the use of the system.

Figure 12 Setup Wizard (main)

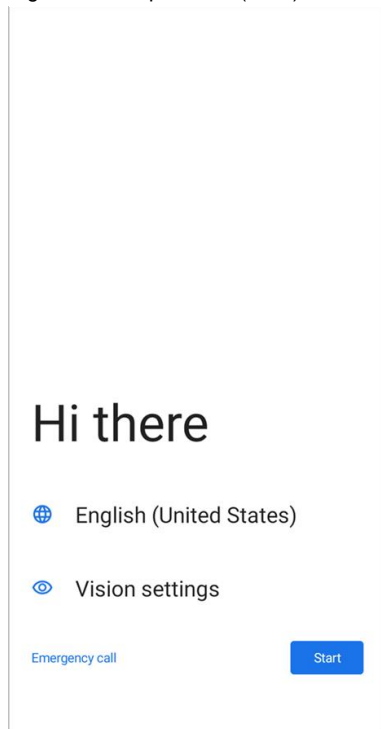
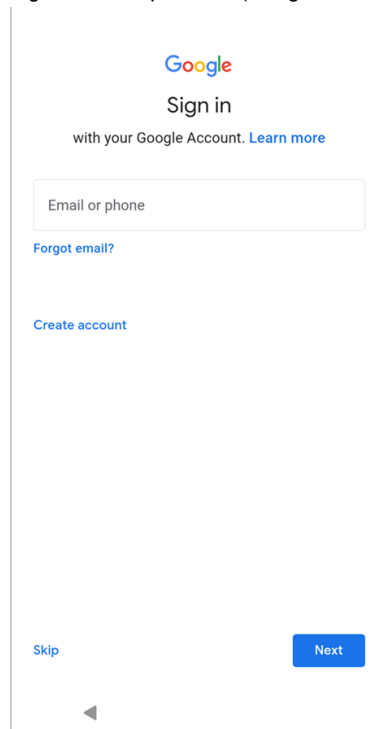

Figure 11 Setup Wizard (Google account)



Learning the Basics

Home Screen

Home screen is a screen displayed after Setup Wizard or pressing the Home button.

Figure 13 Home screen

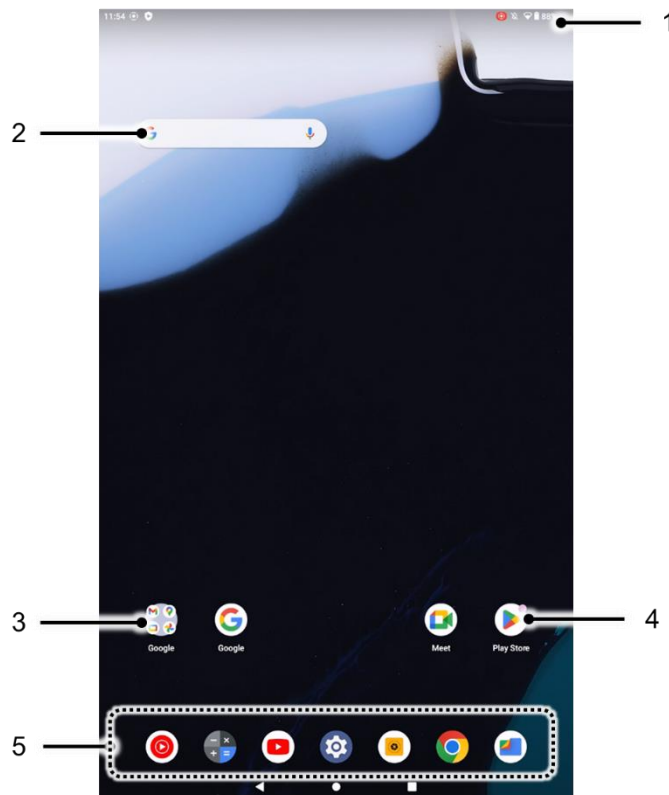



















No	Item	Description
1	Status bar	Indicates tablet status and notification.
2	Google search	Search an item with Google
3	App folder	Apps are organized in the folder. Tap to open the App folder
4	App	Tap to run the application Long-press to see the application's options
5	Favorites tray	Place the frequently used apps

Learning the Basics









Status bar

Time, status icons, and notification icons are on the Status bar.

Status icons

Icon	Description	Icon	Description
	LTE connected		Strong signal
	3G connected		Weak signal
	EDGE connected		Connection issue
	Hotspot enabled		No data connection
	Airplane mode		Connected to a Bluetooth device
	Connected to a Wi-Fi network		
	Battery is full		Battery is low
	Battery is critical low		Cannot recognize battery
	Battery is charging		Alarm is set
	Location service turned on		Vibrate mode

Notification icons

Icon	Description	Icon	Description
	New Email		Connected to VPN network
	Upcoming event		Other input method available
	File uploaded		File downloaded
	File copied		OTG device connected
	There are more notifications		

Learning the Basics

Notification panel

Notification panel displays a list of all notifications. Tap a notification to respond.

To open the Notification panel, drag the Status bar down. To close the panel, swipe it up.

Figure 14 Notification panel

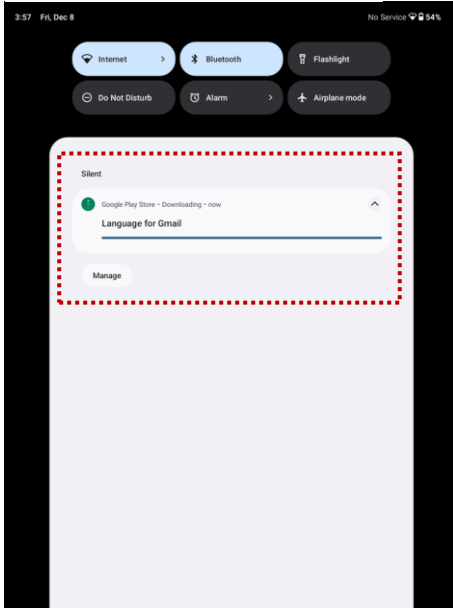

Learning the Basics

Quick setting panel

Quick setting panel contains some frequently used settings such as Wi-Fi, Bluetooth, etc.

To use the Quick setting panel,

1. Open the Notification panel.
2. Drag down the Notification panel.
3. Tap a setting icon to enable / disable the setting or long-press an icon to see more detail.

Figure 15 Quick setting panel

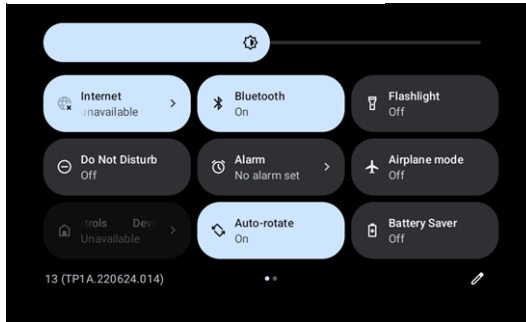

To edit the configuration of Quick setting panel,

1. Tap  on the bottom of the panel.
2. By long-press and dragging the icon, customize the configuration of the panel.

Learning the Basics

Apps & Widget

App folder

To create the app folder, long-press an app icon and drag it to another app icon.

Figure 16 Create app folder

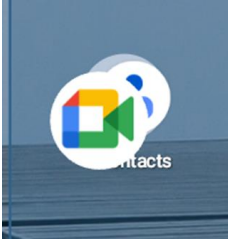

To change the folder name, tap the **Edit Name** and input a new name.

Figure 17 Change app folder name

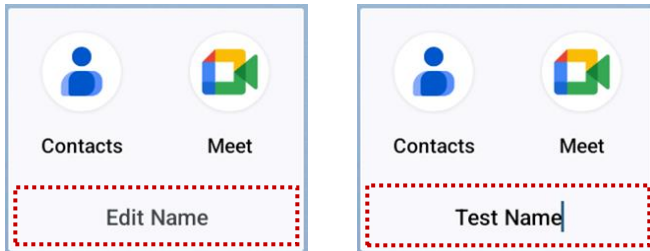

Learning the Basics

App drawer

All installed apps are listed alphabetically in App drawer.

- To open the App drawer, swipe up the Home screen.
- To close the App drawer, swipe down the screen.

Figure 18 App drawer

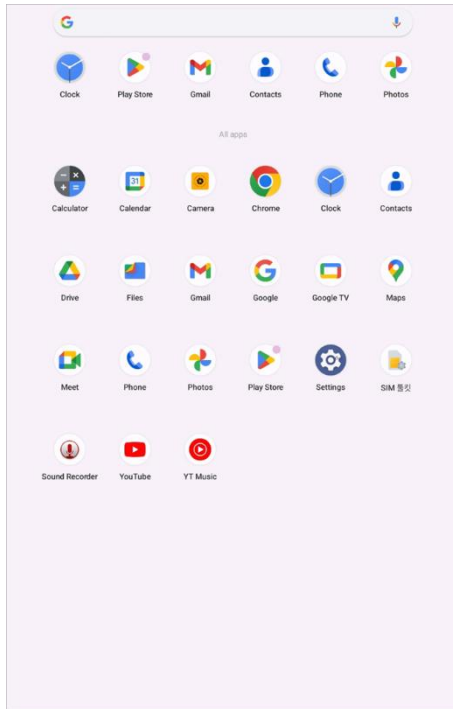

Favorites tray

To organize an app in the Favorites tray,

1. Long-press an app icon from the App drawer. Then, drag it slightly until the Home screen is shown.
2. Place the app icon in the Favorites tray.

Figure 19 Add an app to Favorites tray

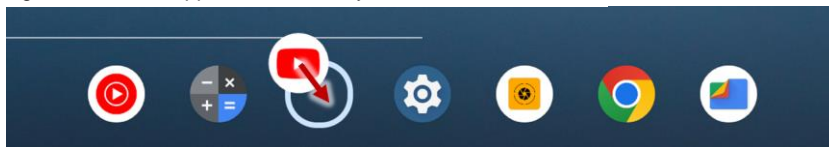

Learning the Basics

Organize app in Home screen

To organize an app in the Home screen,

1. Long-press an app icon from the App drawer. Then, drag it slightly until the Home screen is shown.
2. Place the app icon where you want.

(To cancel to place the app, drag it to **Cancel** area and release.)

Figure 20 Place app in Home screen

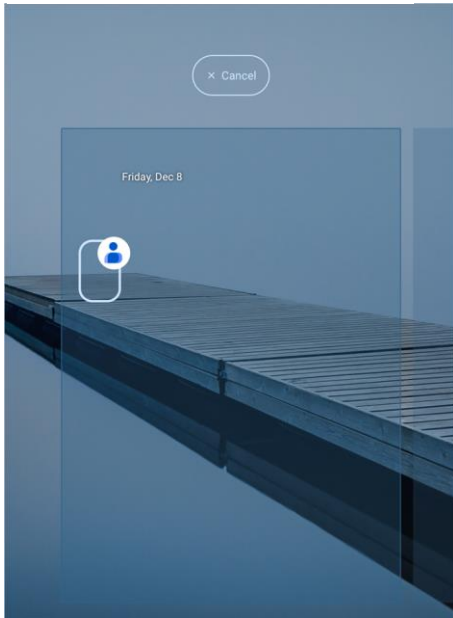

To remove an app or widget in the Home screen,

1. Long-press an app icon or widget.
2. Drag it to **Remove** area and release.

Figure 21 Remove from Home screen

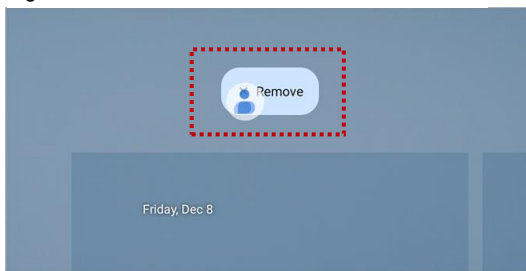

Learning the Basics

Widget

To add a widget in the Home screen,

1. Long-press the empty space of the Home screen.
2. In three menus, select **Widgets**.

Figure 22 Widget menu

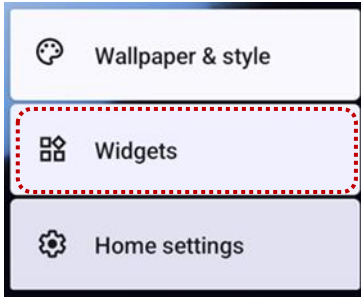

3. Among the list, tap and hold a widget you want to add.
4. Place the widget to the Home screen by dragging.

Learning the Basics

MTP Connection with PC

To transfer the files with a PC, connect the tablet to the PC via USB cable first.

1. Drag down the Status bar and tap **Android System** notification to change the USB preference option.

Figure 23 USB connection notification

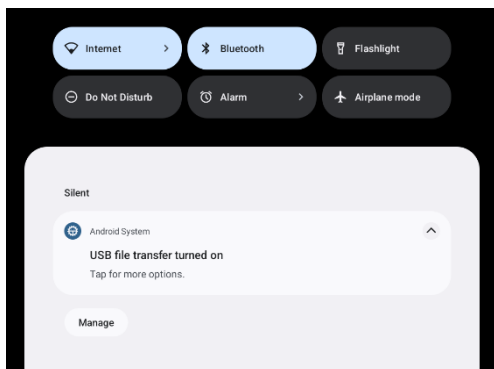

2. Change the option to **File Transfer** from **No data transfer**.

Figure 24 USB Preferences

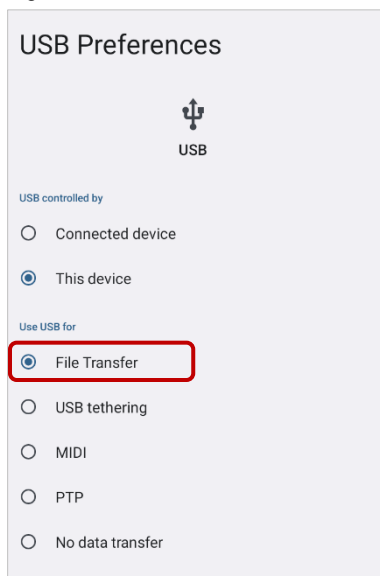

3. Now PC can recognize the connected device. Find PT11 device from the file explorer of the PC.

Figure 25 File explorer on PC

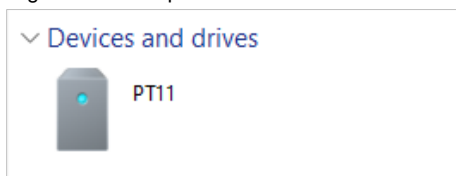

Learning the Basics

Manage the Files

Launch **Files**  to manage the files in the storage.

You can find the folders and files, move / copy them to other location, and delete them from the storage.

Figure 26 Files

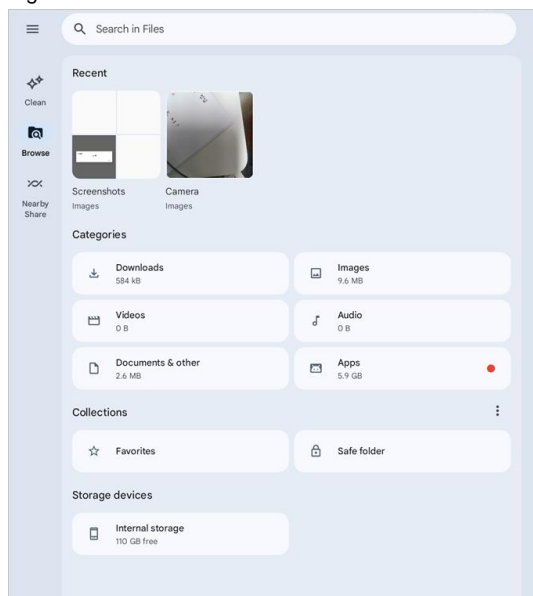

Learning the Basics

Lock the Screen

Protect the tablet from unauthorized personnel by setting up the screen lock.

1. Navigate to **Settings**  > **Security**.
2. Tap **Screen lock**.

Figure 27 Screen lock



3. Choose a screen lock method.
 - None: Screen unlocks immediately
 - Swipe: Swipe the lock screen to unlock (Default)
 - Pattern: Draw a pattern to unlock
 - PIN: Input a PIN to unlock (At least 4 digits)
 - Password: Input a password to unlock (At least 4 characters)

Learning the Basics

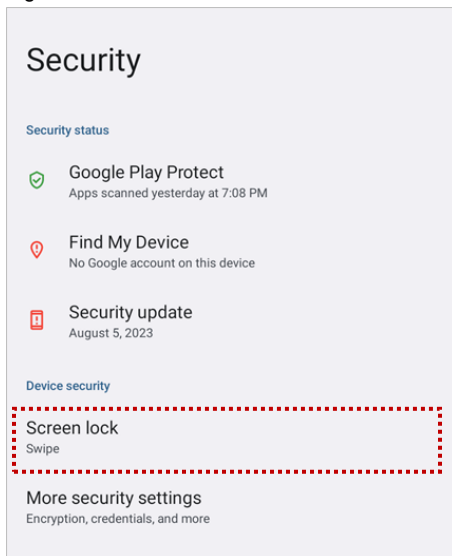
Multi Window

Display two apps together on a split screen.

To set multi window,

1. Tap Recent app button  on the navigation bar.
If you are using the [gesture navigation](#), swipe up from the bottom of the screen, hold, and then release.
2. Swipe the screen to find an app you want to display.
3. Long press the app icon, and select **Split left (top)**.

Figure 28 Configuring multi window



4. Swipe the screen to find another app you want to display on the split screen.
And then, tap the app.

You can adjust the split screen size by dragging the border.

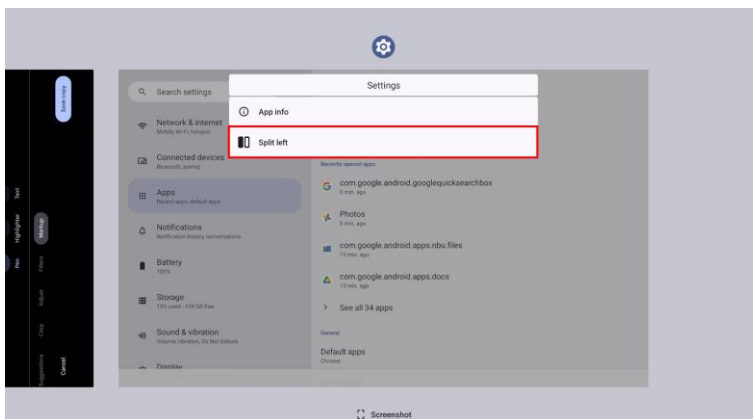
If you drag the border to the edge of the screen, the multi window will be exited.

Figure 29 Adjusting multi window

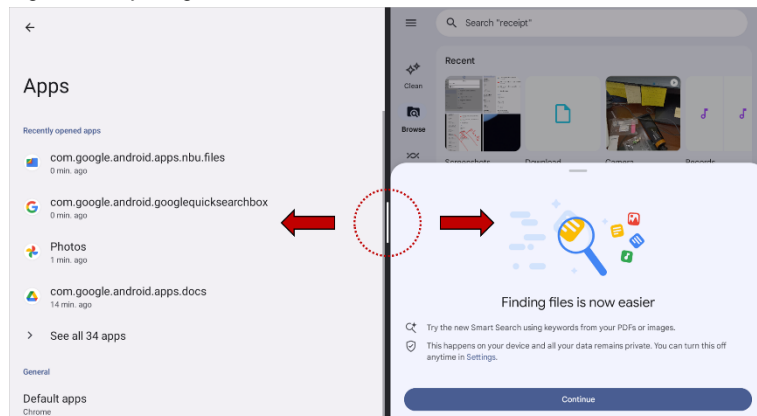

Learning the Basics

Screen Cast

Mirror the tablet screen to the bigger screen such as TV with wireless connection.

1. Open the quick setting panel, and tab the **Screen Cast**.

Figure 30 Quick setting panel - Screen Cast

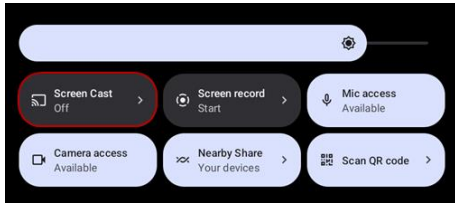

2. Tab **Settings**.

(Or you can access the cast setting from **Settings > Connected devices > Connection preferences**.)

3. Find a screen device from the searched nearby device list and select it.

If the device cannot search the device you want, tap  and select **Enable wireless display**.

Figure 31 Screen Cast

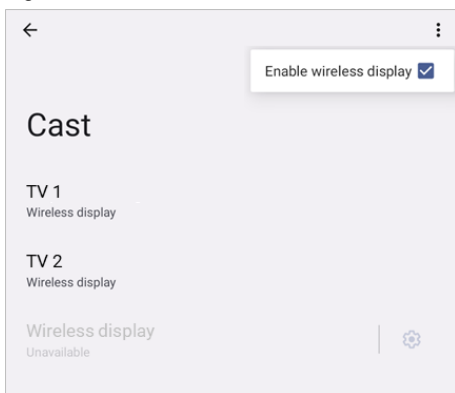



Notice: Check if the screen device (TV) you want to connect supports the screen mirroring feature.

Learning the Basics

Settings

There are two ways to go to **Settings**:

- Open the App drawer and tap **Settings** 
- Open the Quick setting panel and tap gear icon  on the bottom.

Adjust display brightness

To adjust the display brightness level,

- Open Quick setting panel and adjust display brightness bar
- Go to **Settings**  > **Display** > **Brightness level**

Figure 32 Brightness level bar



Caution: Using high brightness levels for long periods may cause eye strain and increase battery consumption.

Adjust sound

To adjust sound volume, go to **Settings**  > **Sound & vibration** and control the Media, Notification, Alarm volume bars.

Figure 33 Volume bars



Caution: Using high volume levels for long periods may cause ear strain and increase battery consumption.

Learning the Basics

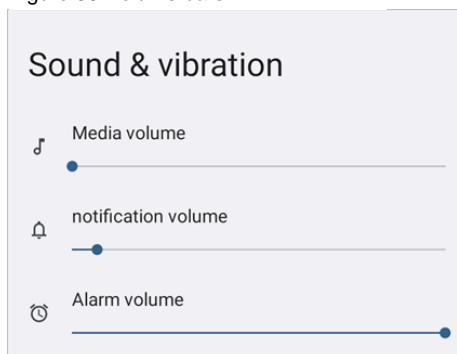
Adjust display and text size

If the display and text size of the screen is too small or too large, adjust the size.

1. Go to **Settings**  > **Display** > **Display size and text**.
2. Referring to the **Preview**, adjust the size controller.

Figure 34 Set font size



Learning the Basics

Enable screen auto rotation

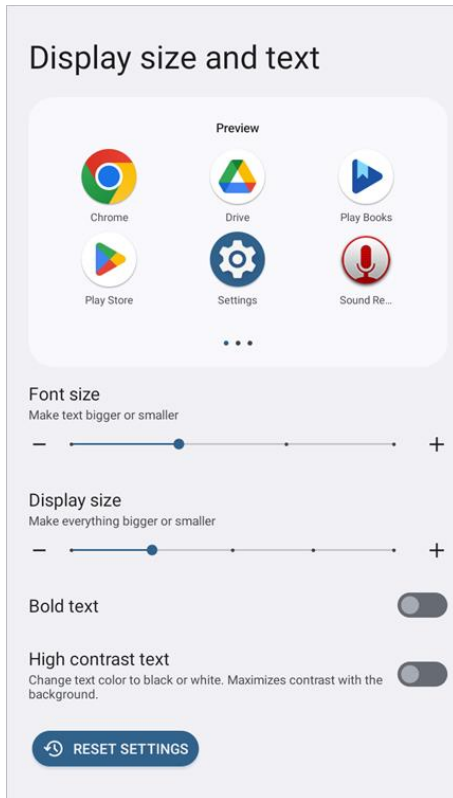
Turn on the auto rotation and rotate the screen automatically according to the direction the PT11 is hold.

Go to Settings > Display, and turn on the **Auto-rotate screen** toggle switch to use the auto rotation feature. Or turn on the **Auto-rotate** from the quick setting panel.

Figure 35 Enable Auto-rotate

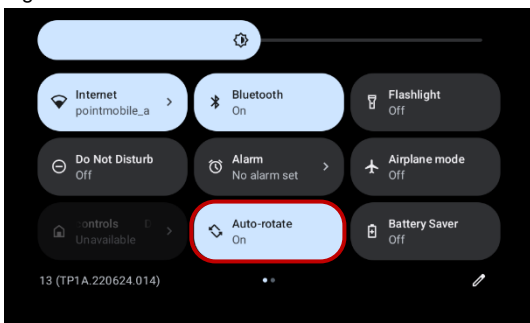

Turn on/off screen by double tap

Tap the touchscreen twice to turn on or off the screen.

You can make this feature not used by **Double tap wake on / off** settings from the **Settings > System > Gestures**.

Figure 36 Double tap wake on / off

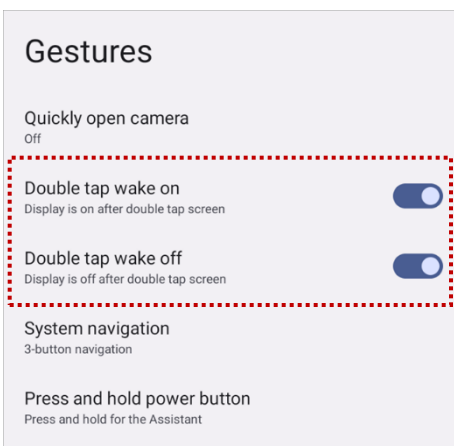

Note: To turn off the screen, tap a blank space in the host screen or lock screen twice.

Using the Buttons

Screenshot

To take a screenshot, use one of the two ways as below.

- Press and hold **Power button + Volume down button** simultaneously.
- Tap Recent apps button  from the navigation bar, and tap **Screenshot**.

The screenshot image will be saved to **Pictures > Screenshots** folder in the internal storage.

Camera

To use the camera, open App drawer and tap Camera application . Figure 37 is a main screen of Camera application.

Figure 37 Camera main screen



No	Name	Description
1	Grid	Display grid on the screen
2	Timer	Set timer (No timer / 2s / 10s)
3	Advanced camera settings	Set advanced settings (Picture size, etc.)
4	Flash	Set flash mode (Activate / Deactivate / Auto mode)
5	QR code scan mode	Enter QR code scanning mode
6	Scene mode	Set the scene mode depending on the photo taking environment
7	Camera switching	Switch the camera between front and rear
8	Gallery	Go to gallery to see the currently taken photos
9	Shutter button	Take a picture or recode a video
10	Mode change button	Change the Camera or Video mode

Wireless

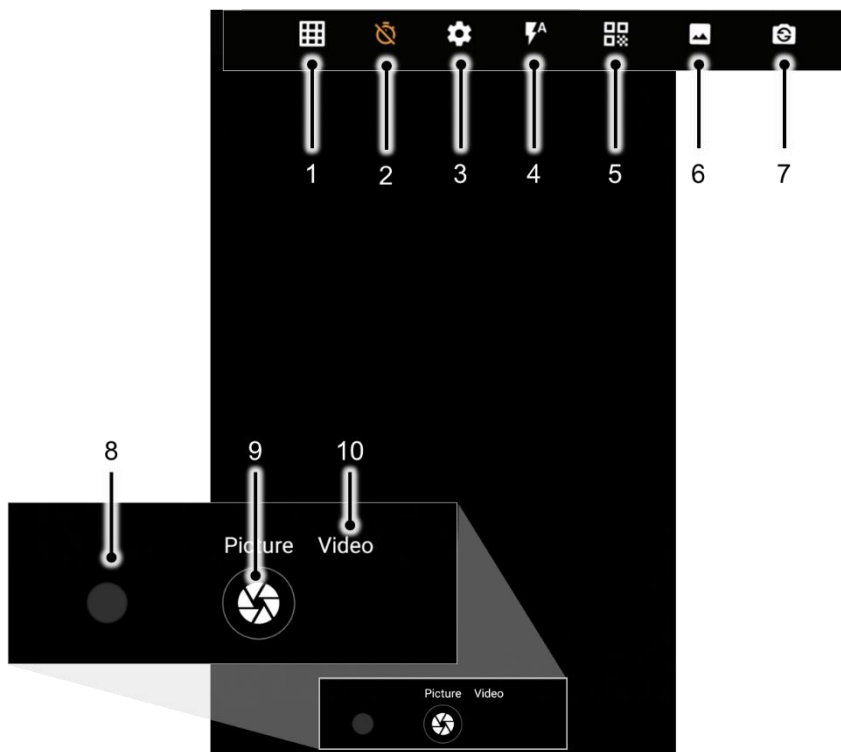
Mobile Network



Note: Mobile network is supported on PT11 LTE SKU only.

To connect mobile network, SIM card is required. Insert SIM card first referring [Install SD & SIM cards](#).

After inserting the SIM card, reboot the tablet. When network is connected, a network icon will be appeared on the status bar.

- **LTE network icon:** 

Find network information and adjust the network settings in **Settings**  > **Network & internet** > **Mobile network**.

Figure 38 Mobile network setting



Wireless

Wi-Fi

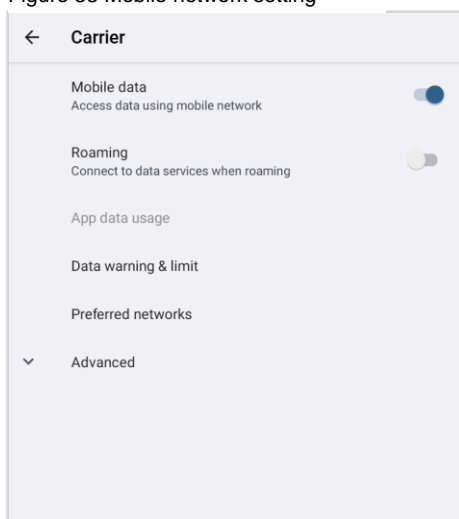
To turn on and connect a Wi-Fi,

1. Go to **Settings**  > **Network & internet** > **Internet**.
2. Tap Wi-Fi toggle switch to enable Wi-Fi.
3. The tablet searches for nearby Wi-Fi signals and lists them in order of signal strength.
4. Select a Wi-Fi SSID to connect.
5. The message **Connected** under the SSID means the tablet complete to connect to the Wi-Fi.

Figure 39 Wi-Fi connected



Note: There are Open Wi-Fi network and Secured Wi-Fi network. You can tell those apart by lock icon (🔒) in the nearby Wi-Fi list.

To connect the secured Wi-Fi network, you need to enter the password.

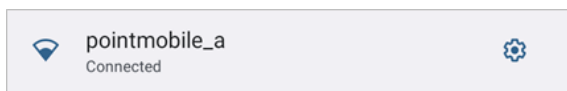
Figure 40 Open Wi-Fi Network

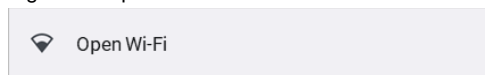
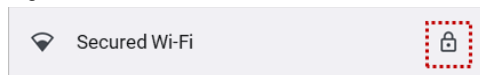
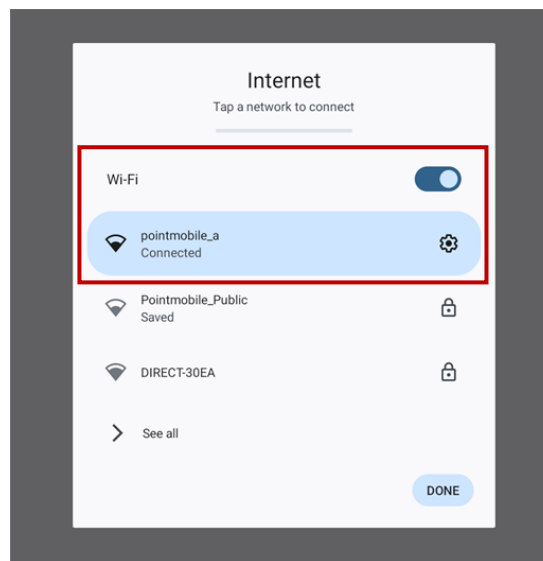
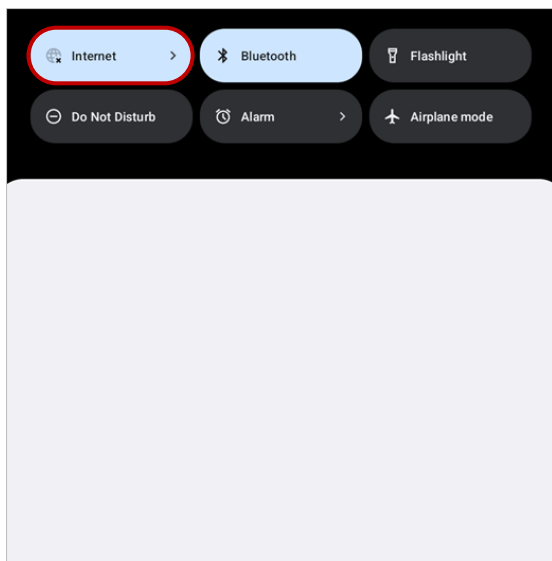

Figure 41 Secured Wi-Fi Network



If there is a saved Wi-Fi network, simply turn on the Wi-Fi through the Quick setting panel. The saved network will be connected automatically.

Figure 42 Wi-Fi in Quick setting panel



Wireless

Hotspot & Tethering

Share a network connection to other devices using a tethering or hotspot.

Figure 43 Hotspot & tethering

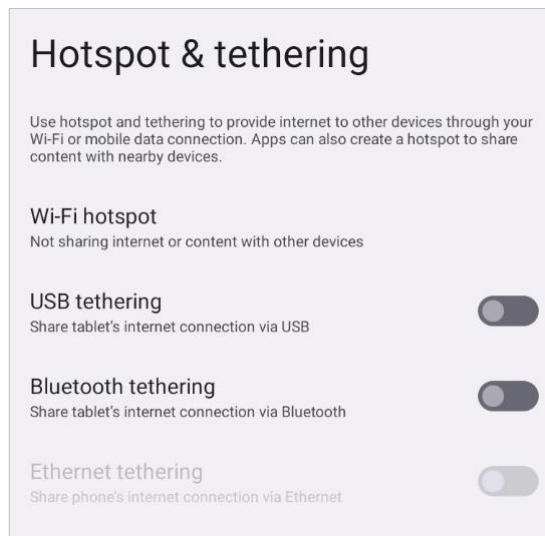

To turn on the hotspot,

1. Go to **Settings > Network & internet > Hotspot & tethering**.
2. Select **Wi-Fi hotspot**.
3. Turn on the **Use Wi-Fi hotspot** switch.
4. If you want, you can modify the hotspot name, security, and password.

Then, the other device can search and connect the hotspot from Wi-Fi list.

If you want to use tethering, choose one of the following options among the Hotspot & tethering menu.

- Bluetooth tethering: Pair your tablet with the other device, and enable Bluetooth tethering.
- USB tethering: Connect your tablet to the other device with a USB cable, and enable USB tethering.
- Ethernet tethering: Connect your tablet to the ethernet with an ethernet cable, and enable Ethernet tethering.

Wireless

Bluetooth

Turn on / off

Bluetooth is turned off as default. There are two ways to turn on the Bluetooth,

- Open quick setting panel and enable  Bluetooth

Figure 44 Bluetooth in Quick setting panel

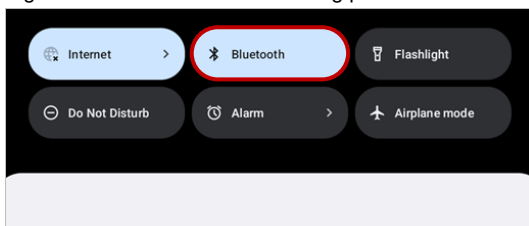

- Go to **Settings**  > **Connected devices** > **Pair new device**

Pair and Connect

To connect with a new device,

1. Go to **Settings**  > **Connected devices**.
2. Tap **Pair new device**.
(Bluetooth will be turned on automatically)
3. Select the device you want to pair among **Available devices** list.

Figure 45 Bluetooth available devices



4. Follow instructions on the screen (Pairing code or pairing confirmation dialog) and tap **PAIR**.

Wireless

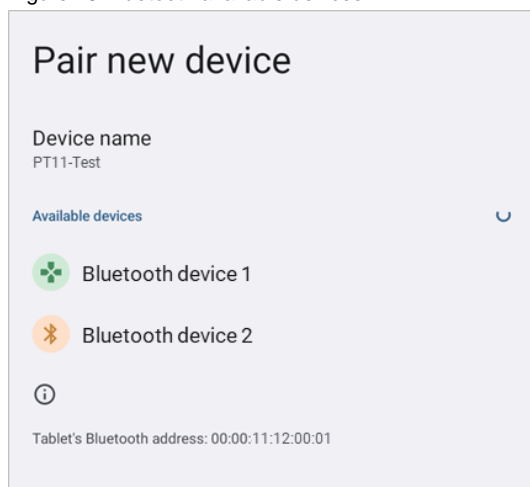
5. When the connection is succeeded, the connected device name is listed under the **Other devices** list.

Figure 46 Bluetooth currently connected

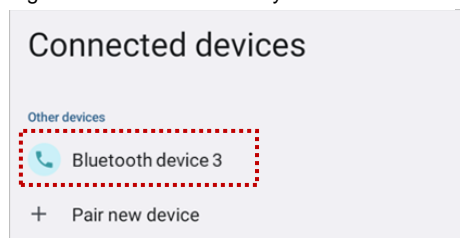

To connect a device previously connected, select the device name from the **Saved devices** list.

Figure 47 Saved devices list

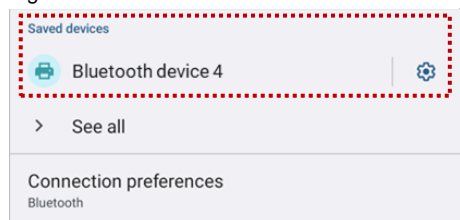

Unpair and Disconnect

To unpair the device, select the name of the device you want to unpair from the **Other devices** list and tap **FORGET** .



Or tap **DISCONNECT**  to disconnect only and not unpair.

Figure 48 Forget device

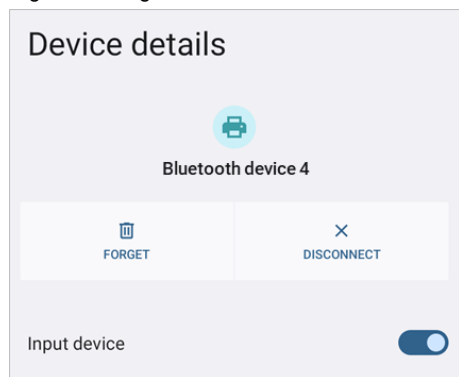

Wireless

Change the Bluetooth device details

Tap device name under **Other devices** list or  icon next to the device name under the **Saved devices** to see device details.

If the device you want is not listed under the **Saved devices**, tap **See all**.

Figure 49 Bluetooth device detail

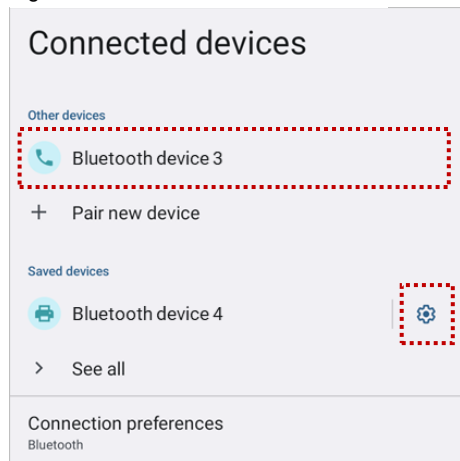

- To change the device's name, tap  on the top of the screen
- Turn other settings on or off (Available depending on device types)

System Maintenance

System Information

Check the system information on the Settings or System Information app.

On Settings

Go to **Settings**  > **About tablet**. Following information can be found.

- Device name
- Legal information & Certificates
- Model & SIM status
- IMEI
- Android version
- IP address
- Wi-Fi MAC address
- Bluetooth address
- Build number

On System Information app

Launch the **System Information** app from app drawer. Following information can be found.

- Version information (Android version, etc.)
- Manufacturer information (Serial number, etc.)

System Maintenance

OS Update

Periodic update improves the performance of the tablet. Point Mobile provides up-to-date OS version via Service Portal and FOTA. Update the tablet via storage, OTG port, and FOTA server. Depending on the workspace environment, choose more suitable method.



Notice: Please backup your data before starting the update process.

OS update via storage

To update the OS using storage,

1. Download an OS image file into the root folder of microSD card or tablet internal storage.
2. (In case of using SD card) Insert SD card to the tablet and then turn the tablet on.
3. Go to **Settings**  > **System** > **System Update**
4. Check if the OS image file shows up under **AVAILABLE VERSIONS**

Figure 50 OS update via storage



5. Tap **UPDATE** to start the update process

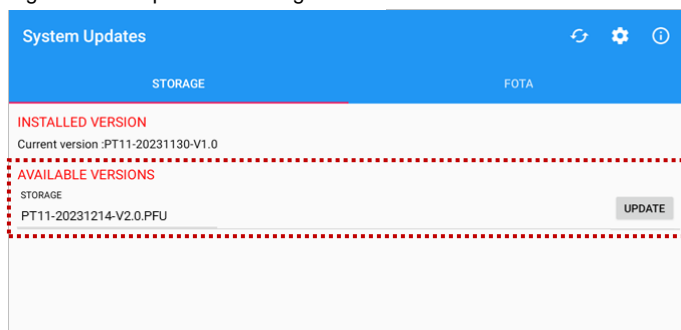

Note: If the OS image file doesn't show up in **AVAILABLE VERSIONS**, check the file is placed in the root folder of storage. System only can recognize the file in the root folder.

System Maintenance

OS update via OTG port

PT11 supports the USB OTG feature.

1. Prepare a formatted USB flash drive for OS update
2. Copy an OS image file to the root folder of the flash drive
3. Connect the flash driver to the PT11
4. Go to **Settings**  > **System** > **System Update**
5. Check if the OS image file shows up under **AVAILABLE VERSIONS**
6. Tap **UPDATE** to start the update process

OS update via FOTA

If PT11 can connect to a network, use the FOTA server for the update.

1. Connect the tablet with a network
2. Go to **Settings**  > **System** > **System Update**
3. Tap **FOTA** tab or Swipe left to move to **FOTA** tab
4. If there is an OS version newer than tablet's one, the server shows the new OS information

Figure 51 OS update via FOTA



5. Tap **Download**
6. Tap **OK** on the **OS Update** dialog to start to download the OS image file
7. To complete the update, rebooting is required.

Tap **OK** on the **Restart required** dialog to restart the tablet

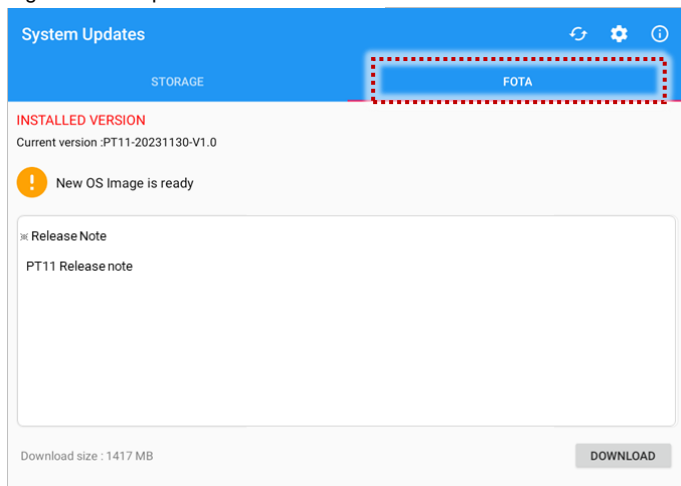
System Maintenance



Note: Basically, OS update via FOTA works over Wi-Fi or Ethernet only. To enable the OS update over Mobile Network too, uncheck the setting value in FOTA Settings. Downloading over the Mobile network may result in additional charges.

Figure 52 FOTA Settings

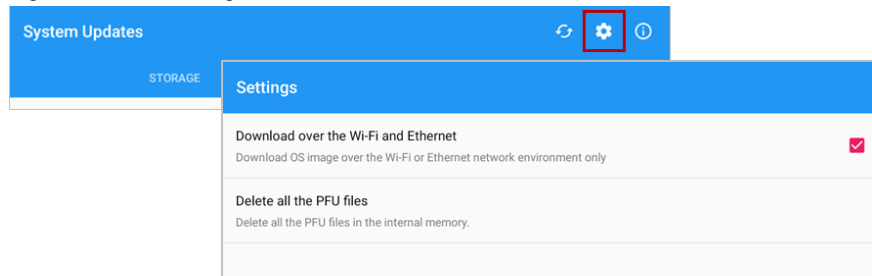

System Maintenance

Factory Data Reset

When PT11 works abnormally or there is a need to reset the tablet, follow the steps below to perform a factory data reset.



Caution: Factory data reset will erase all personalized settings and data saved in the tablet, such as Google account, apps, user data, etc. And factory data reset cannot undo.

Factory data reset via Settings app

If the tablet can be turned on and access **Settings**,

1. Navigate to **Settings**  > **System** > **Reset options**
2. Tap **Erase all data (factory reset)**.
3. After being aware that factory reset will erase all data from the internal storage, tap **Erase all data**

Figure 53 Factory data reset



4. Tap **Erase all data** again to start the factory reset process

System Maintenance

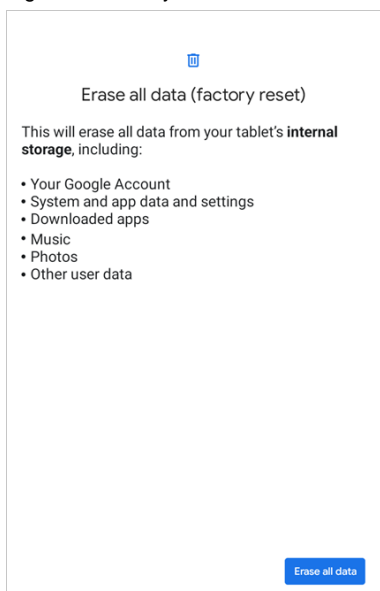
Factory data reset via recovery mode

If tablet works abnormal so does not turn on, try to perform factory data reset through Android recovery mode.

1. Press and hold **power button + Volume Up** buttons simultaneously when PT11 is turned off.

Figure 54 Key combination for recovery mode

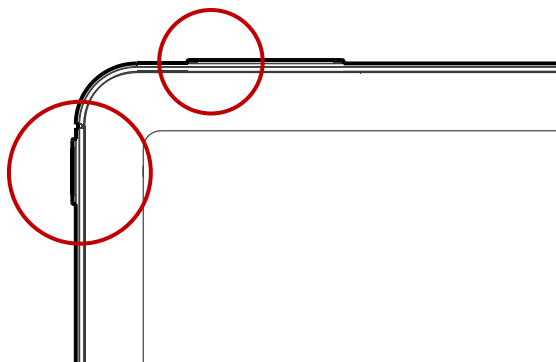

2. When the screen is displayed, release the power button.
3. Select the **Recovery Mode** using the volume up (move) and volume down (select) buttons.

Figure 55 Select boot mode

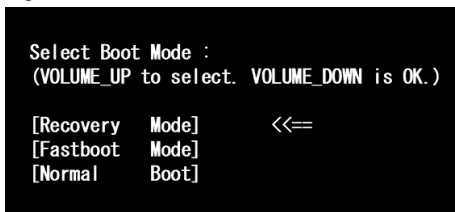

4. If **No command** is displayed, press and release the **Power + Volume Up** buttons at the same time.
5. Using the buttons below, select **Wipe data/factory reset**
 - **Move up/down** – Volume up/down
 - **Select the menu** – Power button

Figure 56 Android recovery mode

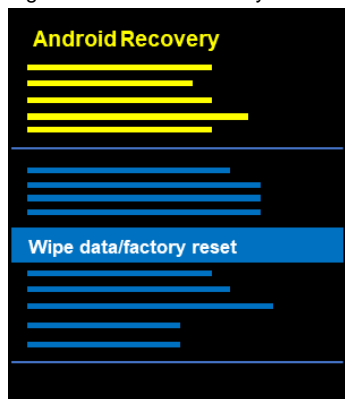

6. Select **Factory data reset**.
7. After wiping the data, select **Reboot system now**

Safety Information

Battery Safety Information

Follow the battery safety guidelines for safe usage, storage, and disposal of Li-ion batteries. Improper battery use may result in a fire, explosion, or other critical hazards.

Battery Safety Guidelines

- Use only Point Mobile approved batteries and charging accessories. Other batteries and chargers may damage the device or result in a fire, leakage, or other hazards.
- Do not expose the battery to excessive heat or cold.
- Do not use or store the battery in or near areas that might get very hot, such as in a parked vehicle, near a heat duct or close to other heat sources.
- Do not allow objects that may cause a short circuit, such as metal objects, corrosive substances, or liquids like water, to contact the battery.
- Do not disassemble, crush, bend, shred, press, or other actions that may damage or deform the battery.
- Do not use or replace the battery on the go or from a high location. Dropping may result in an explosion or fire.
- Do not put any labels, stickers, tags, etc. on the device or battery. Performance of the device or battery, such as sealing, drop, or tumble, could be affected.
- Close supervision is necessary when used near children to avoid the risk of injury.
- If battery leakage is observed, avoid any contact with the skin or eyes and properly dispose of the battery. If contact has been made, wash the affected area with water for 15 minutes and seek medical advice.
- If you notice any type of damage to the battery, such as swelling, dents, and leaks, stop using it immediately and contact Point Mobile.

Battery Charging Guidelines

- Charge the battery in a clean, cool, dry, and ventilated environment.
- Separate the charger from the battery as soon as possible when the battery is fully charged.
- Battery performance can degrade due to the stress of daily charging and discharging. Batteries typically need to be replaced after 300 to 500 charging cycles (full charge-discharge cycles) or when the battery capacity has been reduced to 70 ~ 80% of its original capacity. The actual number of charging cycles varies based on usage patterns, temperature, age, and other factors.

Safety Information

Battery Storage / Disposal Guidelines

- Store the batteries in a clean, dry and ventilated environment within ambient temperature ranges of $20\pm 5^{\circ}\text{C}$.
- For safety regulations, batteries are charged to below 20~30% of full capacity during production.
- When not using batteries for a long period, charge the battery for 30 minutes to 1 hour at least once every 6 months to prevent full discharge and keep the performance.
- Batteries should be stored separately when storing for long periods. Disconnect from any device, charger, or cradle.
- Dispose of used batteries promptly according to local disposal regulations.
- Do not dispose of the battery in fire. It may cause explosion.



Notice: *The battery is consumable. Point Mobile provides a warranty for the battery for 12 months after purchase. If you suspect the battery swelling, change the battery immediately and contact Point Mobile.*



Point Mobile. Co., Ltd.

Offline

Tel: +82-2-3397-7870~1

Fax: +82-2-3397-7872

Address: 26F, Building A, Gasan Publik,
178, Digital-ro, Geumcheon-gu, Seoul, Korea 08513

Online

Website: <https://www.pointmobile.com>

E-mail : pm_ta@pointmobile.com