

PM3 User Manual

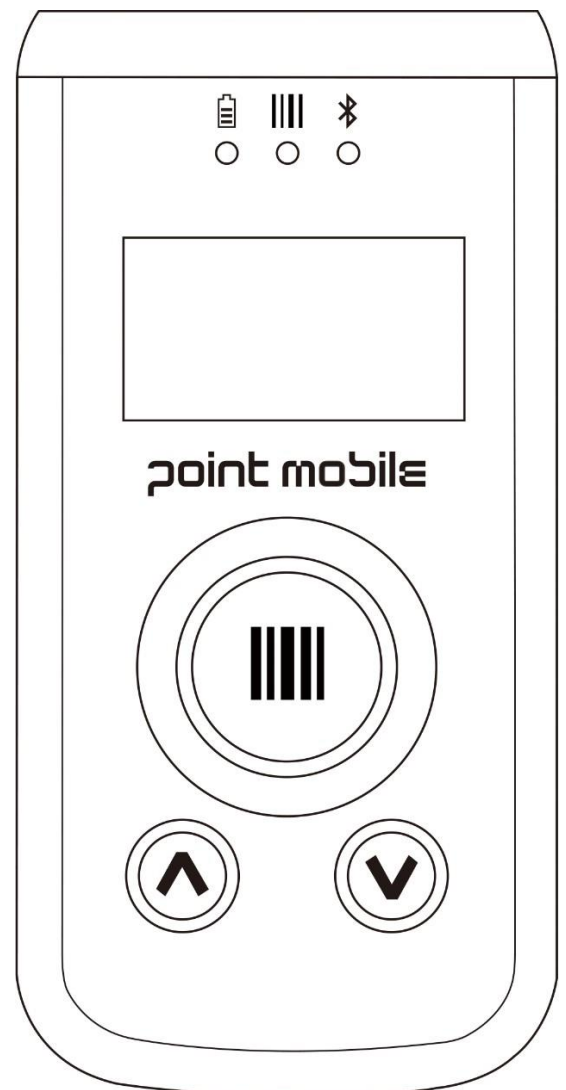

Table of Contents

1. Introduction.....	4
1.1 About PM3 Bluetooth Scanner.....	4
1.2 Symbols in this manual.....	4
1.3 Accessories.....	5
2. Getting Started.....	6
2.1 Charge the Device.....	6
2.2 Turn Your Device On & Off.....	6
3. Get to Know Your Device.....	7
3.1 Front Panel Layout.....	7
3.2 Back Panel Layout.....	7
3.3 Left Side Panel Layout.....	8
3.4 Top Panel Layout.....	8
3.5 Bottom Panel Layout.....	8
3.6 LED Indicator.....	9
3.7 USB Cable.....	9
3.8 Battery Power.....	9
3.9 Sleep Mode.....	9
3.10 PM3 Technical Specifications.....	10
4. Using the Buttons.....	11
5. Using the Image Engine.....	12
5.1 Overview.....	12
5.2 Available Image Engines.....	13
5.3 Depth of Field.....	13
5.4 Supported Bar Code Symbologies.....	13
5.5 To Decode a Barcode.....	13
6. Using the Laser/CCD Engine.....	14
6.1 Overview.....	14
6.2 Available Laser Engines.....	14
6.3 Depth of Field.....	14
6.4 Supported Bar Code Symbologies.....	15
6.5 Decoding a Barcode.....	15

6.6 Scanning Positions.....	16
7. Bluetooth.....	17
7.1 Enabling the Bluetooth	17
7.2 Pairing Bluetooth Devices	17
7.3 Reconnecting HID	17
8. User Menus.....	18
9. Admin Menus	19
10. Initializing the Memory.....	24
11. Using the USB Memory in Connection with PC.....	24
12. Troubleshooting and Note.....	25
12.1 Firmware Update.....	25
12.2 Factory Reset.....	27
13. Safety Regulations.....	28
13.1 Battery Safety.....	28
13.2 General Safety Rules	29
13.3 Power Supply	29
13.4 Laser Safety	30
13.5 LED Safety	31
13.6 CB Scheme	31
13.7 Radio Compliance	31
13.8 WEEE Compliance.....	31
13.9 Canadian Compliance.....	32

1. Introduction

This manual generally provides you with the safety information and basic features and operations of the PM3 device. Please read all safety precautions and this manual carefully before using your device and peripherals to ensure safe and proper use.

1.1 About PM3 Bluetooth Scanner

The new PM3 is the latest generation Bluetooth scanner, combining a pocket-sized form factor. The PM3 is designed for retail warehousing and logistics applications where maximum performance and durability is required in compact Handheld device.

The PM3 is available in different models depending on the options.

1.2 Symbols in this manual

In this manual, some important items are described with the symbols shown below. Be sure to read these items before using this equipment.



WARNING Indicates a potentially hazardous situation which, if not avoided, could result in death serious injury, or serious damage, or fire in the equipment or surrounding objects.



CAUTION Indicates a potentially hazardous situation which, if not avoided, may result in minor or moderate injury, partial damage to the equipment or surrounding objects, or loss of data.



NOTE Indicates information to which you should pay attention when operating the equipment.

1.3 Accessories

Power Supply

AC Adaptor

INPUT: AC100~240V 50/60Hz, OUTPUT: DC5V 0.7A Power Supply

Cables

Packed with the Power Supply

Others

Customized necklace String (when requested)



PM3 Bluetooth Scanner contains the following items basically:

- Bluetooth scanner
- 5V/0.7A AC Adaptor with USB type C cable
- AC Plugs

 **NOTE:** Keep the original packaging for use when sending products to the technical assistance center. Damage caused by improper packaging is not covered under the warranty

2. Getting Started

2.1 Charge the Device

Battery pack is assembled inside of the PM3 Bluetooth scanner. Charge the device with the charging cable for **about 4 hours before initial use**.

1. Attach the appropriate plug adapter to the plug of the power cable.
2. Insert the plug into the appropriate power source.
Plug the Bluetooth scanner power cable into the USB connector on the side end of the unit.

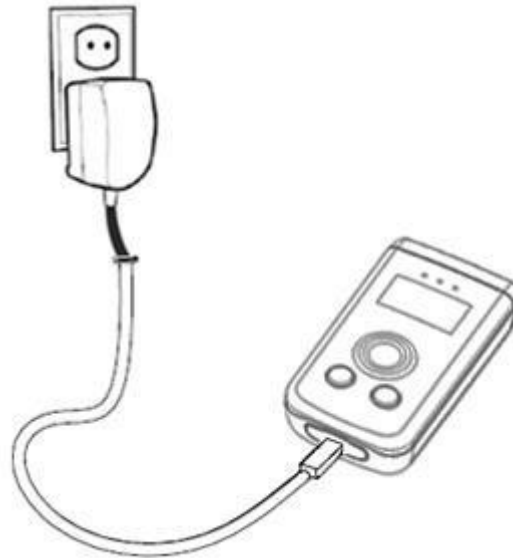

WARNING: Use only Point Mobile-approved peripherals, power cables, and power adapters. Unauthorized peripherals, cables, or power adapters may cause explosion or damage on your device. **DO NOT** attempt to charge damp/wet Bluetooth scanners or batteries. All components must be dry before connecting to an external power source.

Batteries must be charged at a temperature ranging from 0~45°C (±3°C). If you don't follow the guide, it might have a harmful effect on the battery life.

CAUTION: After the device has been charged, disconnect the DC Power Jack. If you stay on that plug-in use, it is possible to break the power cord.

2.2 Turn Your Device On & Off

To turn on, press the **UP button** for 1 second.

To turn off, press the **UP button** for 5 seconds.

3. Get to Know Your Device

3.1 Front Panel Layout

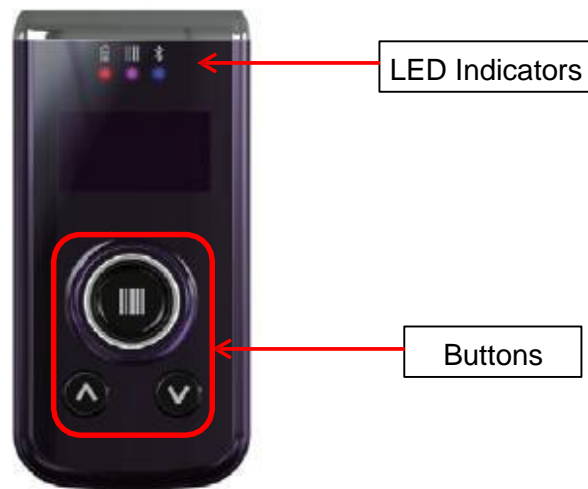

3.2 Back Panel Layout

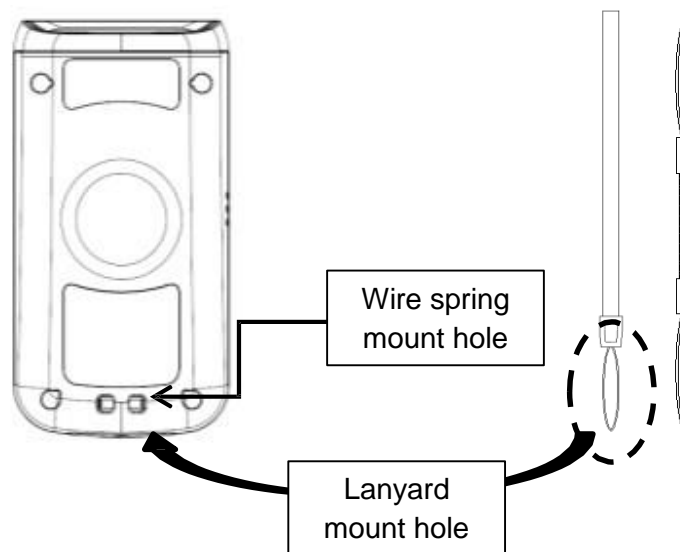

Battery Installed Inside of the Device

For information about battery power, see [Battery Power](#).

Speaker

The integrated speaker sounds audio signals as you scan bar code labels and enter data, the speaker meets the following SPL levels at 10cm:

- 500Hz–70dB
- 1kHz–80dB
- 4kHz–80dB

3.3 Left Side Panel Layout

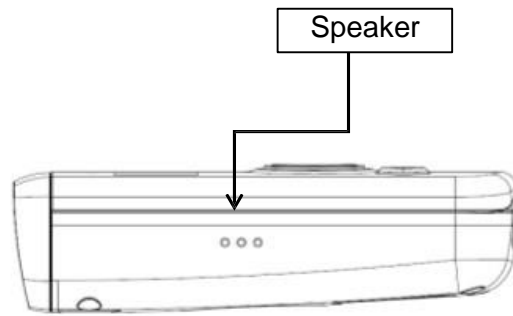

3.4 Top Panel Layout

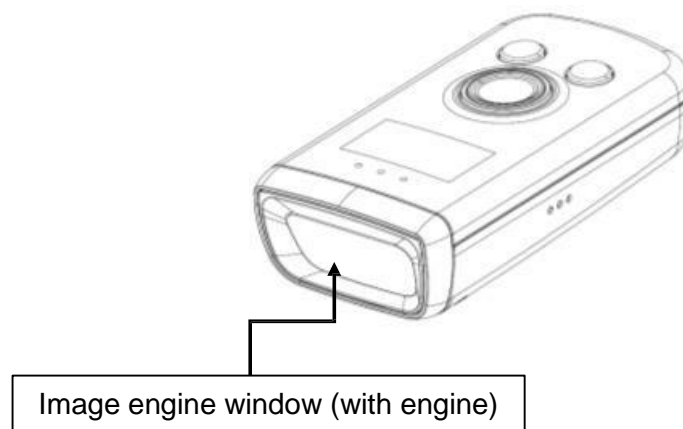
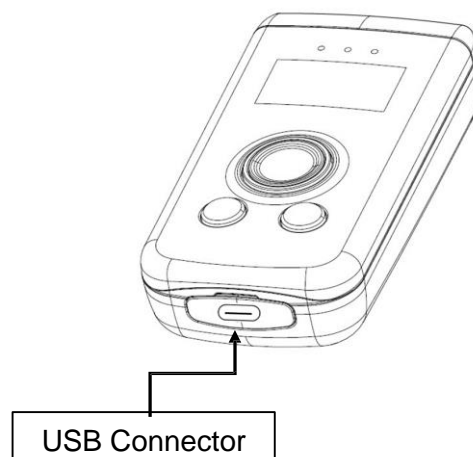

Image Engine Window

The angled image engine reads and decodes most popular bar code symbolizes. For more information, see [Using the Image Engine](#).

3.5 Bottom Panel Layout



USB Port

This connector supports full speed USB 2.0 communication also external power from the adaptor that is included with the terminal. When connected to the adaptor, the terminal is powered and the main battery pack is charging.

3.6 LED Indicator

Shows the information needed to operate your device as follows:

LED Color Meaning

- **Battery LED (Left)**
 - Red Lights when main battery is charging
 - Green Lights when main battery charging has completed.
- **Scan LED (Middle)**
 - Red Lights when a scan fails
 - Blue Lights when a scan pass
- **Bluetooth LED (Right)**
 - Blue Lights when Bluetooth pairing has completed

3.7 USB Cable

The USB type C cable is used when communicating between the terminal and a host computer to transfer data via the USB interface.

3.8 Battery Power

The battery works to prevent data loss when the terminal is used over long periods of time. **The battery must be charged to full capacity before using the BLUETOOTH SCANNER AC Adaptor for the first time!**

Charge the Bluetooth scanner with AC Adaptor for **about 4 hours before initial use.**

3.9 Sleep Mode

Sleep Mode suspends PM3 operation. The device appears to be **off** when in Sleep Mode. The device is programmed to go into Sleep Mode automatically when inactive for a specified period of time. You can set this time period in the **Sleep Timeout** menu.

3.10 PM3 Technical Specifications

Model	PM3
Operating System	Firmware
Processor	ATMEL SAM4S16C, 32-bit ARM® Cortex®-M4 RISC processor 120Mhz
Memory	1MB(PGM), 4MB Storage Flash, 128KB RAM
Display	Bright OLED/ 0.96 inch (21.74mm x 11.18mm Active Area) 128x64 Dot Passive Matrix/Monochrome (Blue)
Scan Engine	1D engine: SE-965HP 2D engine: SE4710 CCD: SE655
Buttons	3 buttons [1 scan button, 2 menu buttons (Up & Down)]
Audio	Built-in speaker
I/O	Full Speed USB v2.0(12Mbps) Client. support USB Disk Mode & USB to Serial mode
Battery	3.7V, 900mAh Lithium Polymer battery
Expected Charge Time	< 4 hours (from Low-Battery Shutdown level)
Charging Peripherals	USB Cable
Operating Temperature	-10°C to 50°C
Charging Temperature	0~45°C (±3°C)
Storage Temperature	-20°C to 60°C
Humidity	95% humidity, non-condensing
Construction	High impact resistant PC housings
Drop	1.5m multiple drops to concrete, MIL-STD-810G
ESD	Air: ± 15kV Direct: ± 8kV
Environmental	Independently certified to meet IP54 standards for moisture and particle resistance (IEC 60529)
Dimensions	78.5mm x 39.0mm x 19.4mm
Weight	SE655: 61g SE965: 65g SE4710: 65g
Bluetooth	Bluetooth Class 2, v4.2
Notification Vibration Motor	Yes

4. Using the Buttons



Scan Button

Located at the center for easy access with either hand.

Scanning Barcodes or choosing options in menu.

Up / Down Button

Located at the bottom left / right.

Moving up / down in the menu

NOTE: Press the UP and DOWN buttons at the same time to move to the main menu

	On Idle Screen	On Menu Screen
SCAN Button	<ul style="list-style-type: none"> Scans Starts/Stops Auto Scan 	<ul style="list-style-type: none"> Selects Menus Selects settings
UP Button	<ul style="list-style-type: none"> Turns off when pressing for 5 seconds Turns on when pressing for 1 second on power OFF Display enters to the menu screen when pressing with DOWN button at the same time 	<ul style="list-style-type: none"> Moves up to the menu above Keeps it moving up when pressing for 3 seconds
DOWN Button	<ul style="list-style-type: none"> Disconnects BT when pressing for 3 seconds if BT is connected Tries to reconnect when pressing for 1 second if disconnected on BT HID mode Display enters to the menu screen when pressing with UP button at the same time 	<ul style="list-style-type: none"> Moves down to the menu below Keeps it moving up when pressing for 3 seconds

5. Using the Image Engine

5.1 Overview

The BLUETOOTH SCANNER contains an SE4710 2D image engine that instantly reads all popular 1D and 2D bar codes and supports omni-directional aiming and decoding or a SE965HP, SE655 1D laser engine that reads all popular 1D bar codes. The image engine can also capture digital images, such as signatures and pictures.

NOTE: It may not read the barcode due to specular reflection if scanning from directly above. Try again after changing angle.

NOTE: It may not read the barcode, if this Bluetooth scanner is too close to or too far from the barcode even if the barcode is within the aiming range. Move the Bluetooth scanner toward or away from the barcode slowly and try again. The aiming range is for reference only.

NOTE: It may not read the barcode if the barcode surface is curved. Scan the barcode at the center of the aiming range.

NOTE: It may not read the barcode if the barcode surface is dirty. Try again after cleaning the barcode.

NOTE: It may not read the barcode if the image engine window is dirty. Try again after wiping the window with a cotton swab or similar soft object gently.

NOTE: It may not read the barcode according to the direct sunlight or the brightness of the surrounding. Try again away from the direct sunlight. Try again after adjusting the brightness of the surrounding if indoors.

NOTE: It may not read the barcode if it is blue on white background. Try again after changing angle or adjusting the brightness of the surrounding.

NOTE: It may not read the barcode if it is black on silver background. Try again after changing angle or adjusting the brightness of the surrounding.

NOTE: Bar codes printed on glossy or laminated paper are best read at angles greater than 5° in relation to the Laser Engine. This prevents bright illumination reflections from being returned to the Laser Engine.

NOTE: Performance may be impacted by bar code quality and environmental conditions

NOTE: Misreading may occur, if the bar code isn't positioned correctly. Recommended scanner beam positions are as follows

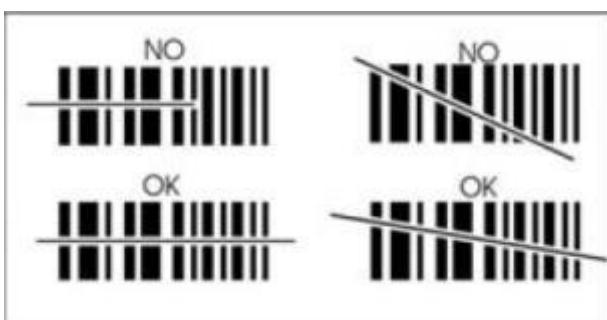
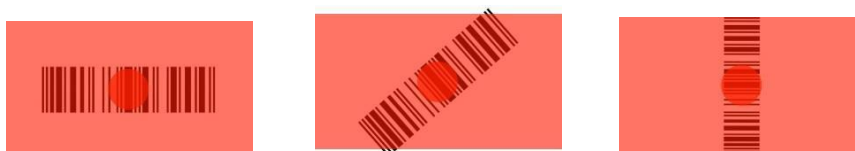

5.2 Available Image Engines

The BLUETOOTH SCANNER is equipped with an SE4710.

5.3 Depth of Field

Depth of Field for SE4710

Bar Code Type	Scan Angle /Focus Position	Near Distance	Far Distance
		Guaranteed	Guaranteed
PDF417, 5mil. 80% MRD	Default	4.25 in/10.79 cm	7.25 in/18.51 cm
UPCA, 13mil. 80% MRD	Default		19.9 in/50.54 cm

5.4 Supported Bar Code Symbologies

Symbology Type	Symbology Name
SE4710 Symbologies	UPC A, UPC E, UPC E1, EAN 8, EAN 13, BOOKLAND EAN, CODE 128, GS1 128, ISBT 128, CODE 39, TRIOPTIC CODE 39, CODE 93, CODE 11, INTERLEAVED 2 OF 5, DISCRETE 2 OF 5, CODABAR, MSI, GS1 DATABAR, GS1 DATABAR LIMITED, GS1 DATABAR EXPANDED, UCC COUPON, CHINESE 2 OF 5, MATRIX 2 OF 5, KOREAN 3 OF 5, US POSTNET, US PLANET, UK POSTAL, JAPAN POSTAL, AUSTRALIA POST, NETHERLANDS KIX CODE, USPS 4CB/ONE CODE/INTELLIGENT MAIL, UPU FICS POSTAL, COMPOSITE CC-C, COMPOSITE CC-A/B, COMPOSITE TLC-39, PDF417, MICROPDF417, DATA MATRIX, MAXICODE, QR CODE, MICRO QR, AZTEC, HAN XIN

5.5 To Decode a Barcode

1. Position the Bluetooth scanner over the barcode.
2. A range of 4–10 inches (10–25 cm) from the bar code is recommended.
3. Project the aiming brackets by pressing and holding the **Scan button**. The Scan LED lights red.
4. Center the aimer crosshair over the bar code. The aiming beam should be oriented in line with the barcode to achieve optimal decoding.
5. When the bar code is successfully decoded, the scan LED lights blue and the terminal beeps.

6. Using the Laser/CCD Engine

6.1 Overview

The BLUETOOTH SCANNER (SE965HP laser version, SE655 CCD version) contains a laser diode that emits a beam toward an oscillating mirror that scans through the code and the reflected light is bounced off of two mirrors back to the collector. The laser version reads all popular 1D bar codes.

 **NOTE:** Performance may be impacted by bar code quality and environmental conditions.

6.2 Available Laser Engines

The BLUETOOTH SCANNER can be equipped with an SE965HP or SE655 laser/CCD engine (depending on the configuration purchased).

6.3 Depth of Field

Depth of Field for SE965HP

Symbol Density/ Bar Code Type/ W-N Ratio	Bar Code Content/ Contrast (Note 1)	Typical Working Ranges	
		Near	Far
5.0 mil Code 128	1234 80% MRD	1.2 in 3.05 cm	7.7 in 19.56 cm
5.0 mil Code 39; 2.5:1	ABCDEFGH 80% MRD	1.2 in 3.05 cm	12.5 in 31.75 cm
7.5 mil Code 39; 2.5:1	ABCDEF 80% MRD	1.1 in 2.79 cm	18.5 in 46.99 cm
10 mil Code 128	1234 80% MRD	1.2 in 3.05 cm Note 3	19.0 in 48.26 cm
13 mil 100% UPC	12345678905 80% MRD	1.6 in 4.06 cm	27.0 in 68.58 cm
15 mil Code 128	1234 80% MRD	1.0 in 2.54 cm Note 3	29.5 in 74.93 cm
20 mil Code 39; 2.2:1	123 80% MRD	1.4 in 3.56 cm Note 3	52.0 in 132.08 cm
55 mil Code 39; 2.2:1	CD 80% MRD	3.4 in 8.64 cm Note 3	100.0 in 254.00 cm
100 mil Code 39; 3.0:1 reflective	123456 80% MRD	2 ft 60.96cm Note 3	17 ft 518.16 cm

Notes:

1. Contrast measured as Mean Reflective Difference (MRD) at 650 nm.
2. Working range specifications at ambient temperature (23°C), photographic quality symbols. Pitch=10°, roll=0°, skew=0°, ambient light < 150 ft-candles using Symbol or equivalent decoder.
3. Dependent on width of bar code.
4. Distances measured from front edge of chassis.

Depth of Field for SE655

Barcode	Distance	Typical	Guaranteed
Code 128 5mil	Near	2.75 in. / 70 mm	3.90 in. / 99 mm
	Far	8.25 in. / 210 mm	6.25 in. / 159 mm
Code 39 5mil	Near	2.25 in. / 57 mm	3.15 in. / 80 mm
	Far	9.75 in. / 248 mm	8.00 in. / 203 mm
Code 39 7.5mil	Near	1.50 in. / 38 mm	2.50 in. / 64 mm
	Far	12.75 in. / 324 mm	10.25 in. / 260 mm
100% UPC-A	Near	2.00* in. / 51 mm	2.25 in. / 57 mm
	Far	15.75 in. / 400 mm	11.00 in. / 279 mm
Code 39 20mil	Near	1.50* in. / 38 mm	2.00* in. / 51 mm
	Far	24.0 in. / 610 mm	18.25 in. / 464 mm

Notes:

- Distances are measured from the front flange surface of the image lens.
- The distances marked with asterisk (*) are a result of the field of view (FOV) limitation.
- Image signal should be with "Raw" option checked
- Successful decoder criteria: Less than 250ms decode time, maximum of two attempts.
- Symbols are to be mounted with a pitch of 15 +/- 3 degrees away from the engine.
- Maximum allowable roll angle of symbols relative to the engine mounting base plane is +/- 3.0 degrees.

6.4 Supported Bar Code Symbologies

Symbology Type	Symbology Name
SE965HP Symbologies	UPC A, UPC E, UPC E1, EAN 8, EAN 13, BOOKLAND EAN, CODE 128, GS1 128(EAN 128), ISBT 128, CODE 39, TRIOPTIC CODE 39, CODE 93, CODE 11, INTERLEAVED 2 OF 5, DISCRETE 2 OF 5, CODABAR, MSI, GS1 DATABAR 14, GS1 DATABAR LIMITED, GS1 DATABAR EXPANDED, UCC COUPON, CHINESE 2 OF 5, MATRIX 2 OF 5, KOREAN 3 OF 5
SE655 Symbologies	UPC A, UPC E, UPC E1, EAN 8, EAN 13, BOOKLAND EAN, CODE 128, GS1 128(EAN 128), ISBT 128, CODE 39, TRIOPTIC CODE 39, CODE 93, CODE 11, INTERLEAVED 2 OF 5, DISCRETE 2 OF 5, CODABAR, MSI, GS1 DATABAR 14, GS1 DATABAR LIMITED, GS1 DATABAR EXPANDED, UCC COUPON, CHINESE 2 OF 5, MATRIX 2 OF 5

6.5 Decoding a Barcode

- Position the Bluetooth scanner over the barcode.
- A range of 4-10 inches (10-25 cm) from the bar code is recommended.
- Project the aiming beam by pressing and holding the **Scan button**. The Scan LED lights red.
- Center the aimer beam horizontally over the bar code and highlight all of the vertical bars of the bar code. The aiming pattern is smaller when the terminal is held closer to the code and larger when the terminal is held farther from the code. Symbologies with smaller bars or elements (mil size) should be read closer to the unit whereas larger bars or elements (mil size)

should be read farther from the unit.

5. When the bar code is successfully decoded, the scan LED lights blue and the terminal beeps.

6.6 Scanning Positions

The aiming beam must be aimed across the entire bar code to provide you with the best scanning performance. The aiming pattern is smaller when the terminal is held closer to the code and larger when the terminal is held farther from the code. Symbologies with smaller bars or elements (mil size) should be read closer to the unit whereas larger bars or elements (mil size) should be read farther from the unit.



7. Bluetooth

Bluetooth wireless technology is a short-range communications technology to connect portable and/or fixed devices while maintaining high levels of security.

7.1 Enabling the Bluetooth

1. Choose **Admin Menu > Bluetooth > Power**
2. Choose **Enabled** and Save

 **NOTE:** Area coverage and Bluetooth radio performance may vary, due to environmental conditions or interference caused by other devices (microwave ovens, radio transmitters, etc.).

7.2 Pairing Bluetooth Devices

Connecting Bluetooth devices usually requires them to be paired; the same PIN must be entered for each device.

1. Select **Pairing** from main menu.
2. Search the Bluetooth device from the smartphone and connect.

If you want to pair with SPP mode,

1. Start Bluetooth pairing from PM3 device.
2. Launch **PMSync** app from your phone and search the device by selecting the button below.

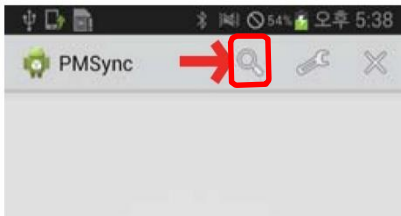

3. Select a device from the list and connect.

7.3 Reconnecting HID

When HID is disconnected while using PM3 device, reconnection is available by following the options below.

1. **Admin Menu > Bluetooth > HID Settings > HID Reconnect > Enabled**
2. Press **DOWN button** for 3 second to reconnect
3. **Bluetooth Connected** is shown on the display when successfully reconnected

8. User Menus

To use the User Menu, Select **User Settings** in the main menu

1. Auto Scan

- You can select Auto Scan and the scanning time.
- Default: Disabled & 0.5 sec

2. Beeper Volume

- Beeper Volume can be adjusted.
- Volume size is available among **None, Low, Middle, High**.
- Default: High

3. Vibrator

- You can select the vibrator working when scanning is succeeded or failed.
- Vibration time can be selected among **None, Short, Middle, Long**.
- Default: None

4. Connect Mode

- Bluetooth transfer mode can be selected.
- Default: **SPP**.

9. Admin Menus

To use the administrator menu, select **Admin Menu** in the main menu.

General uses may not change the settings of the admin menu. Ask for help to an administrator when changes are required.

1. Barcode/Scan

1.1 View Data

- Searching or deleting the saved barcode data

1.2 Symbologies

- You can select use or disuse of barcode type.
- When * is shown at the left corner of the display, it means the barcode type is being used.

1.3 Code Options

- Set the detail symbology options for each of the scanner type

1.4 Scan Options

1.4.1 Scanner Lock

- Scanner Lock Setting

1.4.2 LED On Scan

- LED alert setting when scanning is "success" and "Fail"

1.4.3 Trigger Release

- Operation mode setting for scan trigger. Default is Disabled.
- When enabling, scan button should be pressed in order to apply the trigger time.
- Scanner Trigger becomes "off" when the button is not pressed
- Trigger Time is continued if the button is not pressed when the device is disabled

1.4.4 Trigger Timeout

- Set the Scan Trigger Timeout
- Default: 3 seconds

1.4.5 Power save mode

- Set the Power save mode
- Default: Enabled

1.4.6 Save Timeout (SE965, SE4710)

- Set power save timeout.
- Default: 1 second

1.4.7 Terminator

- Set the terminator text when transmitting the barcode.
- Default: None

1.4.8 Transmit Barcode ID

- Set the Barcode ID Transmission.
- Default: Disabled

1.4.9 Security Level

- Set the Security Level.
- Default: Level 1

1.4.10 Scan Angle (SE965HP)

- Set the angle of the Scanner Beam.
- Default: 47

1.4.11 Adaptive Scan (SE965HP)

- Set the focus of the Scanner Beam to Automatic change.
- Default: Disabled

1.4.12 Picklist Mode (SE4710)

- Set the scanner to scan the barcode only indicated by the aimer.
- Default: Disabled

1.4.13 Redundancy (SE4710)

- Set the Scan level to prevent from misreading.
- Default: Level 1

1.4.14 Inverse 1D (SE4710, SE655)

- Set the scanner whether the color-reversed 1D barcode should be read or not.
- Default: Regular Only

1.4.15 Prefix / Suffix

- Deleting Prefix, Suffix

1.4.16 GS Replace

- Replace or remove the Group Separator.

1.4.17 Length Limit

- Set the maximum length of the decoded data.
- Default: Infinite

1.5 Duplicate

- Set to check if data is duplicated when scanning
- Duplicated data is not saved when the device is set to Enabled
- Default: Disabled

2. Bluetooth

2.1 Power

- Turn on / off the Bluetooth power of the device.
- Default: Enabled

2.2 Wakeup Nulls

- You may transmit, or not transmit the Null data to wake up the module when the Bluetooth module of the Host is on Sleep.
- Default: Disabled

2.3 Connect Alert

- Set the alert if the Bluetooth is disconnected while transmitting the barcode.
- Default: Disabled

2.4 Data Format

- Set the format of the Barcode transmission data. Default is Packet Data.
- Barcode Only: Transmitting the barcode data only
- Packet Data: Transmitting the packet data of the barcode
- Barcode EOT: Transmitting the barcode data with EOT (ASCII code) to identify the end of the barcode.

2.5 Handshake

- You may check if the packet data transmission was "Success" or "Fail" by setting the handshake function.
- Default: Disabled

2.6 HID Settings

2.6.1 Connect OS

- Choose the OS type to be connected with PM3 between Android and Windows.
- Default: Android

2.6.2 HID Reconnect

- Set the function of reconnection on HID transmission mode.
- If there is HID connection record, and it is currently disconnected, you can set it to reconnection by using DOWN button. Refer to [Reconnecting HID](#) chapter.

2.6.3 HID Keyboard

- Set the Keyboard input method of the connected device.
- Default: US

2.6.4 HID Delay

- Set the time of HID text transmission to get help with stable transmission
 - Initial Delay: Set initial delay
 - Char. Delay: Set inter-character delay
 - CRLF Delay: Set CRLF delay

2.6.5 HID Control Char

- You can transmit the values of ASCII (0x01 ~ 0x1F) which is not expressed by the keyboard.
- Default: Disabled

2.6.6 HID Sync

- Setting the synchronization on the HID transmission mode

2.6.7 HID Non-Print

- Set to transmit the non-printable (Hexadecimal value which cannot parse ASCII).

3. Configuration

3.1 UI Settings

3.1.1 Language

- Set interface language (English, Korean, Chinese).

3.1.2 Auto Exit Time

- Setting the operation time of auto exit from the menu.

3.1.3 Display Format

- Setting the display format of the scan result and information.

3.2 USB Settings

3.2.1 USB Mode

- You can select the USB connection method. See [Using the USB memory in connection with PC.](#)

3.3 System Settings

3.3.1 Sleep Timeout

3.3.2 Date/Time

3.3.3 Button Lock

3.3.4 Menu Lock

3.3.5 Power Save

3.3.6 Factory Reset

3.3.7 F/W Update

- Updating is available when you enter the password.
Admin password is required. Refer to [Firmware Update.](#)

4. Device Info

4.1 F/W Version

4.2 Memory Info

4.3 Battery Info

4.4 H/W Revision

4.5 Serial Number

4.6 Part Number

4.7 Scanner Type

4.8 Scanner S/N

4.9 Scanner F/W

4.10 BT MAC Addr.

4.11 BT F/W Ver.

10. Initializing the Memory

To delete the data saved in storage:

1. Select **Reset Memory** in the main menu
2. Check the message of **Erase All Data?** and select **Yes**
3. Wait until deleting is completed

11. Using the USB Memory in Connection with PC

When connecting with PC, you can select the serial type and disk type. Basic setting is serial type.

To use your device with disk type, set as follows.

1. **Admin Menu-> Configuration -> USB Settings -> USB Mode -> USB Disk.**
2. Check **Flash Erase and Reset** message and select **Yes**.
3. Wait until memory is completely deleted.
4. After deleting, your device is automatically reset and operates with USB memory from this moment.

12. Troubleshooting and Note

12.1 Firmware Update

When PM3 does not work as expected, check the firmware version of your PM3 in **Admin Menu > Device Info > F/W Version**.



You can check the latest version and download the update package (Firmware file and update tool) from [Point Mobile Service Portal](#) > Download list > PM3+ Resources (FW) & Document.

NOTE: Please contact to your distributor or Point Mobile sales team if you want to download firmware in Service Portal.

If the firmware version is old, update the firmware as following steps.

Step 1. Make PM3 to Firmware Update Mode

1. Press **UP** and **DOWN** button simultaneously to go to main menu.
2. Navigate to **Admin Menu > Configuration > Sys. Settings > F/W Update**.

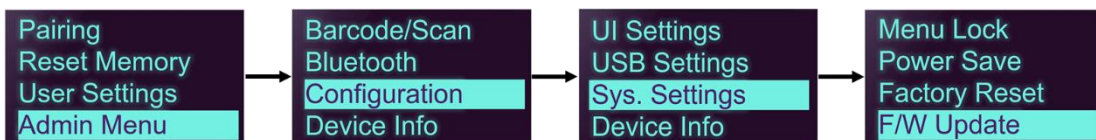

3. Enter **UP > UP > DOWN > SCAN** button in order.

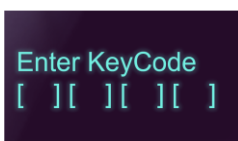

4. Select **ROM Boot** and then, select **Save** and **Yes**.

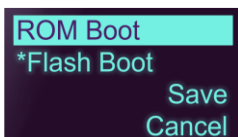

5. After the PM3 boots up in ROM mode, Scan LED lights red and Bluetooth LED light blue.

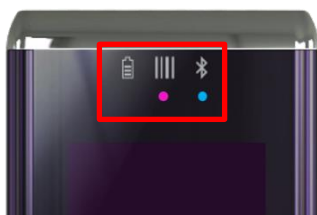

Step 2. Update PM3 Firmware

1. Extract the update tool (PM3-FWTool.zip) file you downloaded from Service Portal.
2. Execute **PM3SingleDownloaderSetup.msi** and install following the install wizard.

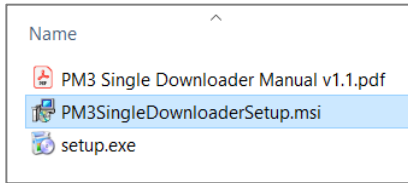

3. After installation, execute **PM3 Single Downloader** from desktop screen.
4. Connect PM3 with your PC using USB cable.

NOTE: PM3 must be in ROM mode (Update mode).

5. Check if the appropriate port number is displayed. And then, click **SELECT** to browse the firmware file (.bin file).

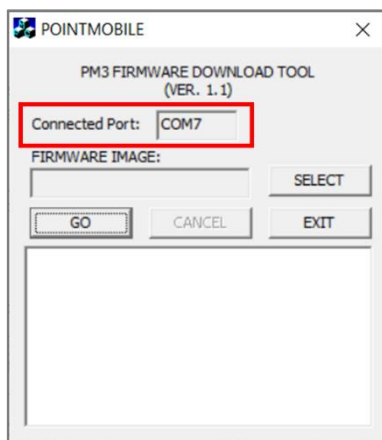

6. Select the firmware file and click **GO**.
7. Wait until the process is done.

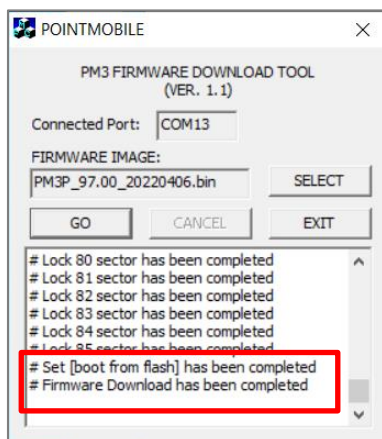

Step 3. After update

After updating the PM3, disconnect the USB cable from the PM3.

To boot the PM3 up to normal mode, press **UP + DOWN + Scan button** simultaneously.

12.2 Factory Reset

Hard Reset

The device is reset when pressing the **SCAN**, **UP**, and **DOWN** buttons at the same time.

Factory Reset

If the device operates abnormally even if you performed a hard reset, it may be because wrong value setting. Restore the device by factory reset.

 **CAUTION:** After factory reset, all settings are initialized, and the saved barcode in the storage is deleted.

1. In the main menu, navigate to **Admin Menu** -> **Configuration** > **Sys. Settings**

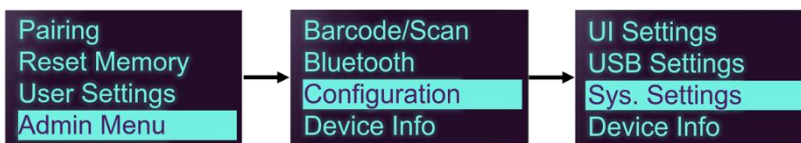

2. Select **Factory Reset**



3. Select **Yes** to perform a factory reset and wait until completed.

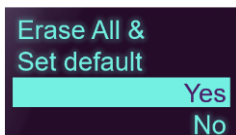

13. Safety Regulations

This section outlines the safety precautions associated with using PM3 Bluetooth scanner.

 **NOTE:** PM3 Bluetooth scanners meet or exceed the requirements of all applicable standards organizations for safe operation. However, as with any electrical equipment, the best way to ensure safe operation is to read this manual carefully before performing any type of connection to the Bluetooth scanner and operate them according to the agency guidelines described in the manual.

13.1 Battery Safety

Follow battery safety guidelines in this manual for safe usage and disposal of Li-ion batteries. Improper battery usage may result in an explosion, fire, or other critical hazards.

Battery Usage & Disposal Guidelines

1. Use only Point Mobile approved batteries and charging accessories. Other batteries and charger may damage the device.
2. Do not disassemble or modify the battery. Do not bend, shred, deform the battery.
3. Do not expose the battery to excessive heat or cold. Do not place the battery into a microwave oven or dryer.
4. Do not short-circuit the battery or allow a foreign object to battery contacts.
5. Do not burn, expose to water, or other liquids the battery.
6. If battery leakage is observed, avoid any contact with the skin or eyes. If contact has been made, wash the affected area with water for 15 minutes, and seek medical attention.
7. Follow the local regulations for the disposal of used batteries.
8. Do not store or charge the battery in direct sunlight or in areas prone to get hot such as in a parked vehicle, near a heat duct, or close to other heat sources.

Battery Charging Guidelines

1. Do not charge the battery in or near areas with materials that could obstruct charging or cause a short-circuit.
2. Do not charge the battery in the excessive hot or cold area.
3. Separate the charger from the battery as soon as possible when the battery is fully charged.

Battery Storage Guidelines

Storing the batteries is as important as using it safely. Battery is a core part of the device's performance so that you should treat the batteries safely.

1. Batteries should be stored in the clean, dry and ventilated environment within ambient temperature ranges of 20 ± 5 °C
2. Keep batteries away from corrosive substances.
3. Keep batteries away from fire and heat.
4. Batteries are charged while producing to below 20 ~ 30 % of full capacity for safety regulations.

5. Charge it for 30 minutes –1hour at least once every six months to prevent full discharge and keep the performance, when you are not using the battery for a long period.

 **NOTE** The battery is consumable goods. Point Mobile provides warranty for battery in 6 months after purchase. If you suspect the battery swelling, change the battery and contact Point Mobile to use safely.

13.2 General Safety Rules

CAUTION

Use only the components supplied by the manufacturer for the specific PM3 being used.

Do not attempt to disassemble the PM3 Bluetooth scanner, as it does not contain parts that can be repaired by the user. Any tampering will invalidate the warranty.

When replacing the battery or at the end of the operative life of the PM3 Bluetooth scanner, disposal must be performed in compliance with the laws in force in your country.

Do not submerge the PM3 Bluetooth scanner in liquid products.

13.3 Power Supply

The power supply for this device has met applicable FCC/CE/CCC/UL /safety requirements. Please adhere to the following safety instructions per UL guidelines:

- FAILURE TO FOLLOW THE INSTRUCTIONS OUTLINED MAY LEAD TO SERIOUS PERSONAL INJURY AND POSSIBLE PROPERTY DAMAGE.
- IMPORTANT SAFETY INSTRUCTIONS – SAVE THESE INSTRUCTIONS.

WARNING

- DANGER – TO REDUCE THE RISK OF FIRE OR ELECTRIC SHOCK, CAREFULLY FOLLOW THESE INSTRUCTIONS.

Use only Point Mobile-approved power supply. Use of a non-Point Mobile-approved power supply may be dangerous and the warranty does not cover damage to the device caused by non-Point Mobile-approved power supply. The package includes international AC plugs. The AC plugs must be plugged in the power supply before the power supply itself is plugged on the wall outlet. The power supply is intended to be correctly oriented in a vertical or horizontal or floor mount position.

13.4 Laser Safety

CAUTION

A Class 2 laser is safe because the blink reflex limits the exposure to no more than 0.25 seconds. It only applies to visible-light lasers (400–700 nm). Class-2 lasers are limited to 1mW continuous wave, or more if the emission time is less than 0.25 seconds or if the light is not spatially coherent. Although staring directly at the laser beam momentarily causes no known biological damage, avoid staring at the beam as one would with any very strong light source, such as the sun. Avoid that the laser beam hits the eye of an observer, even though reflective surfaces such as mirrors, etc.

The laser light is visible to the human eye and is emitted from the window indicated in the figure.

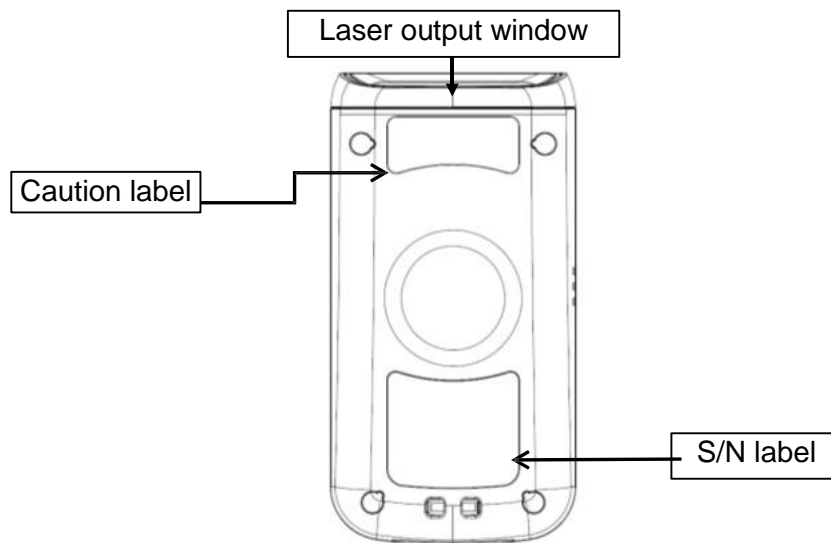



If the above laser light label is attached to your device, it indicates the product contains a laser engine or laser aimer that emits the laser light. The following information is provided to comply with the rules imposed by international authorities and refers to the correct use of PM3 Bluetooth scanner.

Laser Safety Statement

This product has been tested in accordance with and complies with CDRH 21 CFR 1040.10 and 1040.11 and IEC 450825-1 Ed 2 (2007) except for deviations pursuant to Laser Notice No 50, dated June 24, 2007. LASER LIGHT. DO NOT STARE INTO BEAM. CLASS 2 LASER PRODUCTS. 1 mW MAX OUTPUT: 650nm.

For installation, use and maintenance, it is not necessary to open the device.

 **WARNING:** Do not attempt to open or otherwise service any components in the optics cavity. Opening or servicing any part of the optics cavity by unauthorized personnel may violate laser safety regulations. The optics system is a factory only repair item.

 **WARNING:** Use of controls or adjustments or performance of procedures other than those specified herein may result in exposure to hazardous visible laser light.

 **WARNING:** Use of optical systems with the scanner will increase eye hazard. Optical instruments include binoculars, microscopes, eye glasses and magnifying glasses.

13.5 LED Safety

The LED output on this device has met IEC62471 LED safety and certified to be under the limits of a CLASS 1 LED product.

13.6 CB Scheme

This device complies with CB Scheme IEC 60950-1

13.7 Radio Compliance

PM3 RF terminals are in conformity with all essential requirements of the R&TTE Directive

(1999/5/EC). This device is marked with  in accordance with the Class II product requirements specified in the R&TTE Directive, 1999/5/EC. The device is intended for use throughout the European Community; PAN European Frequency Range: 2.402 ~ 2.480 GHz.

Restrictions for use in France are as follows:

- Indoor use: maximum power (EIRP*) of 100 mW for the entire 2.400 ~ 2.4835 GHz
- Outdoor use: Maximum power (EIRP*) of 100 mW for the 2.400 ~ 2.454 GHz band and maximum power (EIRP*) of 10 mW for the 2.454 ~ 2.483 GHz band.



The CE mark on the device indicates that the system has been tested to and confirm with the provisions noted within the 2004/108/EC Electromagnetic Compatibility Directive and the 2006/95/EC Low Voltage Directive, 1999/5/EC (R&TTE), and 2011/65/EU (RoHS). Point Mobile shall not be responsible for use of our product with equipment (i.e., power supplies, personal computers, etc.) that is not CE marked and does not comply with the Low Voltage Directive.

13.8 WEEE Compliance

Information for the user in accordance with the European Commission Directive 2012/19/EU of the European Parliament and of the Council of 4 July 2012 on Waste Electrical and Electronic Equipment (WEEE)

This product has required the extraction and use of natural resources for its production. It may contain hazardous substances that could impact health and the environment, if not properly disposed. In order to avoid the dissemination of those substances in our environment and diminish the pressure on the natural resources, we encourage you to reuse, recycle and recover the product. If the product is disposed according to the Directive, it will avoid potentially negative consequences to the environment and human health which otherwise could be caused by incorrect disposal.



The product marked with crossed out wheeled bin must be disposed separately from municipal waste.

For more detailed information about disposal, reuse, and recycle system, contact your local or regional waste administration.

13.9 Canadian Compliance

This device complies with Industry Canada license-exempt RSS standard(s). Operation is subject to the following two conditions:

- (2) this device may not cause interference, and (2) this device must accept any interference, including interference that may cause undesired operation of the device.